

**Model 2060**  
**Universal Weight Indicator**



**User Instructions**

**Avery Weigh-Tronix is a trademark of the Illinois Tool Works group of companies whose ultimate parent company is Illinois Tool Works Inc (“Illinois Tool Works”). Copyright © 2018 Illinois Tool Works. All rights reserved.**

No part of this publication may be reproduced by making a facsimile copy, by the making of a copy in three dimensions of a two-dimensional work and the making of a copy in two dimensions of a three-dimensional work, stored in any medium by electronic means, or transmitted in any form or by any means, including electronic, mechanical, broadcasting, recording or otherwise without the prior written consent of the copyright owner, under license, or as permitted by law.

This publication was correct at the time of going to print, however Avery Weigh-Tronix reserves the right to alter without notice the specification, design, price or conditions of supply of any product or service at any time.

# Table of Contents

<b>Chapter 1 General Information and Warnings</b> .....	7
About this Manual .....	7
Text Conventions .....	7
Special Messages .....	7
Installation .....	8
Safe Handling of Equipment with Batteries .....	8
Routine Maintenance .....	9
Cleaning the Machine .....	9
Training .....	9
Sharp Objects .....	10
FCC and EMC Declarations of Compliance .....	10
Declaration of Conformity .....	11
<b>Chapter 2 Overview</b> .....	12
Front Panel and Keys .....	12
Front Panel Keys .....	13
Home Screen .....	14
Adjusting screen contrast .....	14
Using the alphanumeric keypad .....	14
Menus .....	14
Standard Print Formats .....	15
<b>Chapter 3 Installation</b> .....	17
Mounting the Model 2060 .....	17
Instructions for V mount .....	17
Instruction for Ram Mount .....	17
Cable Connections and Power Requirements .....	18
AWT05-509201 4+ Pin Amp Bottom Plate .....	18
AWT05-509202 4x 5Pin AWT Bottom Plate .....	18
Connectors .....	19
Routing the Scale Interface Cable .....	20
Connecting to a Convenience Outlet .....	20
Power Connections - Battery .....	21
Wiring 2060 Indicator to Equipment Power Systems .....	23
12 Volt Power Systems (one and two 12 V batteries) .....	23
24 Volt Power Systems .....	24
Grounded Power Systems .....	24
Power Connections - AC .....	25
Optional Communications Connections .....	26
Additional Connectors .....	27
I/O Connector Pins (9 pin connector) .....	27
<b>Chapter 4 Quick Start Calibration Guide</b> .....	28
Calibrate the 2060 with a Standard Configuration Number .....	28
Determine the Configuration Number .....	28
Configuration Codes .....	30
Enter the Configuration Code Number Parameter (Cfg Num) .....	31
Configuration Code Numbers for Common Applications: .....	32
Custom Configuration Number for AWTX Weigh Bars .....	33
Determine Configuration Number .....	33
Determine Custom Calibration Number .....	34
Custom Number Table .....	34
Enter Configuration Code Number (Cfg Num) .....	38
Enter Custom Configuration Number (Cust.Cfg) .....	38
Custom Configuration Number Calibration .....	39

Configuring the 2060 for Other Brand Weigh Bars and Loadcells .....	40
Custom Calibration Number .....	40
<b>Chapter 5 Menus .....</b>	<b>42</b>
Accessing the menus .....	42
<b>Menu Navigation .....</b>	<b>43</b>
Exiting the Menus .....	43
User menu .....	45
The User submenu .....	45
The About submenu .....	46
The Audit submenu .....	47
Diag menu .....	48
Scale .....	48
Cur.Zero .....	48
Display .....	49
Buttons .....	49
Ports .....	49
Inputs .....	49
Outputs .....	50
Options .....	50
Logs .....	51
BSQ .....	51
DigJbox .....	51
Admin menu .....	52
Calibrate .....	54
Zero procedure .....	54
Span procedure .....	55
Linearity ( <i>Linear</i> ) procedure .....	56
Build Up procedure .....	56
Input procedure (key-in calibration) .....	56
Gravity procedure .....	57
Display procedure .....	57
Cal Unit procedure .....	57
Print procedure .....	58
Cfg Num .....	58
Cust.Cfg .....	58
Span Adj .....	58
Scale menu .....	58
<i>Capacity</i> .....	59
<b><i>Dvision</i> .....</b>	<b>59</b>
Units .....	59
Stable .....	60
AZT .....	60
Filter .....	60
Ranges .....	62
2,3 Range .....	62
Type .....	64
Roc .....	64
DigJbox .....	64
Traffic .....	64
System menu .....	65
Site .....	65
Display .....	66
Buttons .....	67
D-Vals .....	67
Tare .....	69
Config .....	69

Archive .....	70
Serial .....	70
Update .....	70
Password .....	71
Z-Lock .....	71
Beeper .....	71
Num Scl .....	71
Ports menu .....	72
Serial .....	72
Enet .....	73
Protcl .....	75
P.F. Edit .....	77
PLC .....	77
Printer .....	79
File .....	79
Options .....	81
Opt232 .....	81
USB .....	81
<b>Chapter 6 Application menu .....</b>	<b>82</b>
Accessing the Application menu .....	83
Auto Settings .....	84
Totals Settings .....	85
App Settings .....	85
App Info .....	86



# 1 General Information and Warnings

## 1.1 About this Manual

---

This manual is divided into chapters by the chapter number and the large text at the top of a page. Subsections are labeled using the 1.1 and 1.1.1 convention. The names of the chapter and the next subsection level appear at the top of alternating pages of the manual to remind you of where you are in the manual. The manual name and page numbers appear at the bottom of the pages.

### 1.1.1 Text Conventions

---

Key names are shown in **bold** and reflect the case of the key being described. If a key has dual functions, the function is shown first followed by the key name in parentheses and in bold, such as in these examples: **F1**, **SELECT**, **PRINT**, etc.

Displayed messages appear in ***bold italic*** type and reflect the case of the displayed message.

### 1.1.2 Special Messages

---

Examples of special messages you will see in this manual are defined below. The heading words have specific meanings to alert you to additional information or the relative level of hazard.



---

***DANGER!***  
*THIS IS A DANGER SYMBOL.*  
*DANGER MEANS THAT FAILURE TO FOLLOW SPECIFIC PRACTICES OR PROCEDURES WILL CAUSE INJURY OR DEATH.*

---



---

***ELECTRICAL WARNING!***  
*THIS IS AN ELECTRICAL WARNING SYMBOL.*  
*ELECTRICAL WARNINGS MEAN THAT FAILURE TO FOLLOW SPECIFIC PRACTICES OR PROCEDURES MAY RESULT IN ELECTROCUTION, ARC BURNS, EXPLOSIONS OR OTHER HAZARDS THAT MAY CAUSE INJURY OR DEATH.*

---



---

***WARNING!***  
*This is a Warning symbol.*  
*Warnings mean that failure to follow specific practices and procedures may have major consequences such as injury or death.*

---



---

***CAUTION!***  
*This is a Caution symbol.*  
*Cautions give information about procedures that, if not observed, could result in damage to equipment or corruption to and loss of data.*

---



---

**NOTE:** This is a Note symbol. Notes give additional and important information, hints and tips that help you to use your product.

---

## 1.2 Installation

---



---

**NO USER SERVICEABLE PARTS. REFER TO QUALIFIED SERVICE PERSONNEL FOR SERVICE.**

---

### 1.2.1 Safe Handling of Equipment with Batteries

---



---

**CAUTION:** Danger of explosion if battery is incorrectly replaced. Replace only with the same or equivalent type recommended by the manufacturer. Dispose of used batteries according to the manufacturer's instructions.

---

---

**ATTENTION:** Il y a danger d'explosion s'il y a remplacement incorrect de la batterie, remplacer uniquement avec une batterie du même type ou d'un type équivalent recommandé par le constructeur. Mettre au rebut les batteries usagées conformément aux instructions du fabricant.

---



## 1.3 Routine Maintenance

---



**IMPORTANT:** This equipment must be routinely checked for proper operation and calibration. Application and usage will determine the frequency of calibration required for safe operation.

---



**ELECTRICAL WARNING!**  
ALWAYS TURN OFF THE MACHINE AND ISOLATE FROM THE POWER SUPPLY BEFORE STARTING ANY ROUTINE MAINTENANCE TO AVOID THE POSSIBILITY OF ELECTRIC SHOCK.

---



**CAUTION:** Do not weld on or near the 3060 or any part of the scale system such as Weigh Bars. Excessive heat and / or high currents may cause internal damage. Physically remove the 2060 from any equipment it is mounted to and disconnect it from the power source. Make ground connection as far away from any scale part (cables, Weigh Bar, etc.) as possible.

---

## 1.4 Cleaning the Machine

---

**Table 1.1 Cleaning DOs and DON'Ts**



DO	DO NOT
Wipe down the outside of standard products with a clean cloth, moistened with water and a small amount of mild detergent	Attempt to clean the inside of the machine
Spray the cloth when using a proprietary cleaning fluid	Use harsh abrasives, solvents, scouring cleaners or alkaline cleaning solutions
	Spray any liquid directly on to the display windows

## 1.5 Training

---

Do not attempt to operate or complete any procedure on a machine unless you have received the appropriate training or read the instruction books.

To avoid the risk of RSI (Repetitive Strain Injury), place the machine on a surface which is ergonomically satisfactory to the user. Take frequent breaks during prolonged usage.

## 1.6 Sharp Objects

---

Do not use sharp objects such as screwdrivers to operate the keys.

## 1.7 FCC and EMC Declarations of Compliance

---

### **United States**

---

This equipment has been tested and found to comply with the limits for a Class A digital device, pursuant to Part 15 of the FCC Rules. These limits are designed to provide reasonable protection against harmful interference when the equipment is operated in a commercial environment. This equipment generates, uses, and can radiate radio frequency energy and, if not installed and used in accordance with the instruction manual, may cause harmful interference to radio communications. Operation of this equipment in a residential area is likely to cause harmful interference in which case the user will be required to correct the interference at his own expense.

### **Canada**

---

This digital apparatus does not exceed the Class A limits for radio noise emissions from digital apparatus set out in the Radio Interference Regulations of the Canadian Department of Communications.

Le présent appareil numérique n'émet pas de bruits radioélectriques dépassant les limites applicables aux appareils numériques de la Classe A prescrites dans le Règlement sur le brouillage radioélectrique édicté par le ministère des Communications du Canada.

### **European Countries**

---

**WARNING:** This is a Class A product. In a domestic environment, this product may cause radio interference in which the user may be required to take adequate measures.

# 1.8 Declaration of Conformity



EN	EU	DE	FR	NL	EU- Conformiteitsverklaring	IT	ES
<p><b>Declaration of Conformity</b></p> <p>Model/Type: 2060/RD60/RD60RCV60-CE</p> <p>Name and address of the manufacturer: Avery Weigh-Tronix® Fountain Lane Southwick West Midlands B66 2LP ENGLAND</p> <p>This declaration of conformity is issued under the sole authority of the manufacturer.</p> <p>Object of the declaration:  RD60M RCV60-CE</p> <p>The object of this declaration, which is defined in the Commission's standards and specifications, is in conformity with the relevant Union harmonization legislation:</p> <p>Applicable Directives (harmonized standards and specifications): 2014/53/EU EN 60950-1:2007 Electromagnetic Compatibility EN 60950-1:2007 EN 14122:2009 2014/30/EU EN 60950-1:2006 Electrical equipment with certain voltage limits with certain voltage limits EN 60950-1:2006 EN 62311</p>	<p><b>Declaration of Conformity</b></p> <p>Model/Type: 2060/RD60/RD60RCV60-CE</p> <p>Name and address of the manufacturer: Avery Weigh-Tronix® Fountain Lane Southwick West Midlands B66 2LP ENGLAND</p> <p>This declaration of conformity is issued under the sole authority of the manufacturer.</p> <p>Object of the declaration:  RD60M RCV60-CE</p> <p>The object of this declaration, which is defined in the Commission's standards and specifications, is in conformity with the relevant Union harmonization legislation:</p> <p>Applicable Directives (harmonized standards and specifications): 2014/53/EU EN 60950-1:2007 Electromagnetic Compatibility EN 60950-1:2007 EN 14122:2009 2014/30/EU EN 60950-1:2006 Electrical equipment with certain voltage limits with certain voltage limits EN 60950-1:2006 EN 62311</p>	<p><b>Konformitätserklärung</b></p> <p>Model/Type: 2060/RD60/RD60RCV60-CE</p> <p>Name and address of the manufacturer: Avery Weigh-Tronix® Fountain Lane Southwick West Midlands B66 2LP ENGLAND</p> <p>Die alleinige Verantwortung für die Ausstellung dieser Konformitätserklärung liegt bei dem Hersteller.</p> <p>Gegenstand der Erklärung:  RD60M RCV60-CE</p> <p>Das oben beschriebene Objekt der Erklärung ist in Übereinstimmung mit den einschlägigen Harmonisierungsvorschriften der Union:</p> <p>Anzuwendende Richtlinien (Normen oder technische Spezifikationen): 2014/53/EU EN 60950-1:2007 Elektromagnetische Verträglichkeit EN 60950-1:2007 EN 14122:2009 2014/30/EU EN 60950-1:2006 Elektrische Betriebsmittel mit bestimmter Verwendung innerhalb bestimmter Spannungsgrenzen EN 60950-1:2006 EN 62311</p>	<p><b>Déclaration UE de conformité</b></p> <p>Modèle/Type: 2060/RD60/RD60RCV60-CE</p> <p>Nom et adresse du fabricant: Avery Weigh-Tronix® Fountain Lane Southwick West Midlands B66 2LP ANGLÈTERRE</p> <p>La présente déclaration de conformité est établie sous la seule autorité du fabricant.</p> <p>Objet de la déclaration:  RD60M RCV60-CE</p> <p>L'objet de cette déclaration, défini dans les normes de la législation de l'Union harmonisation de l'Union applicable:</p> <p>Les directives en vigueur (Les normes harmonisées ou les spécifications techniques): 2014/53/UE EN 60950-1:2007 Compatibilité électromagnétique EN 60950-1:2007 EN 14122:2009 2014/30/UE EN 60950-1:2006 Matériel électrique employé dans certaines limites de tension EN 60950-1:2006 EN 62311</p>	<p><b>Conformiteitsverklaring</b></p> <p>Model/Type: 2060/RD60/RD60RCV60-CE</p> <p>Naam en adres van de fabrikant: Avery Weigh-Tronix® Fountain Lane Southwick West Midlands B66 2LP ENGLAND</p> <p>Dit conformiteitsverklaring wordt verklaard onder uitsluitende verantwoordelijkheid van de fabrikant.</p> <p>Voorwerp van de verklaring:  RD60M RCV60-CE</p> <p>Met betrekking tot het bovenstaande object is de fabrikant in overeenstemming met de desbetreffende harmonisatievoorschriften van de Unie:</p> <p>Toepasselijke richtlijnen (harmonisatievoorschriften en technische specificaties): 2014/53/EU EN 60950-1:2007 Elektromagnetische compatibiliteit EN 60950-1:2007 EN 14122:2009 2014/30/EU EN 60950-1:2006 Elektrisch materiaal dat gebruikt wordt in bepaalde spanningen EN 60950-1:2006 EN 62311</p>	<p><b>Dichiarazione di Conformità UE</b></p> <p>Modello/Tip.: 2060/RD60/RD60RCV60-CE</p> <p>Nome e indirizzo del fabbricante: Avery Weigh-Tronix® Fountain Lane Southwick West Midlands B66 2LP INGHILTERRA</p> <p>La presente dichiarazione di conformità è rilasciata sotto la responsabilità del fabbricante.</p> <p>Objetto della dichiarazione:  RD60M RCV60-CE</p> <p>L'oggetto della dichiarazione, descritto anteriormente, è conforme con la legislazione di armonizzazione pertinente della Unione:</p> <p>Directive applicabili (Norme armonizzate o specifiche tecniche): 2014/53/UE EN 60950-1:2007 Compatibilità elettromagnetica EN 60950-1:2007 EN 14122:2009 2014/30/UE EN 60950-1:2006 Materiale elettrico destinato ad essere utilizzato in aree con determinati limiti di tensione EN 60950-1:2006 EN 62311</p>	<p><b>Declaración UE de Conformidad</b></p> <p>Modelo/Tip.: 2060/RD60/RD60RCV60-CE</p> <p>Nombre y dirección de fabricante: Avery Weigh-Tronix® Fountain Lane Southwick West Midlands B66 2LP INGHILTERRA</p> <p>La presente declaración de conformidad se emite bajo la responsabilidad del fabricante.</p> <p>Objeto de la declaración:  RD60M RCV60-CE</p> <p>El objeto de esta declaración, descrita anteriormente, es conforme con la legislación de armonización pertinente de la Unión:</p> <p>Directivas aplicables (Normas armonizadas u especificaciones técnicas): 2014/53/UE EN 60950-1:2007 Compatibilidad electromagnética EN 60950-1:2007 EN 14122:2009 2014/30/UE EN 60950-1:2006 Material eléctrico destinado a ser con determinados límites de tensión EN 60950-1:2006 EN 62311</p>	
<p><b>Additional information:</b></p> <p>Note 1: ITV Ltd trading as Avery Weigh-Tronix Office registered: News House, Station Road, Egham, Surrey, TW20 9LB, England</p>	<p><b>Additional information:</b></p> <p>Note 1: ITV Ltd trading as Avery Weigh-Tronix Office registered: News House, Station Road, Egham, Surrey, TW20 9LB, England</p>	<p><b>Additional information:</b></p> <p>Note 1: ITV Ltd trading as Avery Weigh-Tronix Office registered: News House, Station Road, Egham, Surrey, TW20 9LB, England</p>	<p><b>Additional information:</b></p> <p>Note 1: ITV Ltd trading as Avery Weigh-Tronix Office registered: News House, Station Road, Egham, Surrey, TW20 9LB, England</p>	<p><b>Additional information:</b></p> <p>Note 1: ITV Ltd trading as Avery Weigh-Tronix Office registered: News House, Station Road, Egham, Surrey, TW20 9LB, England</p>	<p><b>Additional information:</b></p> <p>Note 1: ITV Ltd trading as Avery Weigh-Tronix Office registered: News House, Station Road, Egham, Surrey, TW20 9LB, England</p>	<p><b>Additional information:</b></p> <p>Note 1: ITV Ltd trading as Avery Weigh-Tronix Office registered: News House, Station Road, Egham, Surrey, TW20 9LB, England</p>	<p><b>Additional information:</b></p> <p>Note 1: ITV Ltd trading as Avery Weigh-Tronix Office registered: News House, Station Road, Egham, Surrey, TW20 9LB, England</p>
<p>Signed for and on behalf of: Avery Weigh-Tronix 1000 Armstrong Drive, Falmouth, MN, 56031-1439, USA on 2017-05-08</p> <p>K.Dieret Global Head of R&amp;D</p>	<p>Signed for and on behalf of: Avery Weigh-Tronix 1000 Armstrong Drive, Falmouth, MN, 56031-1439, USA on 2017-05-08</p> <p>K.Dieret Global Head of R&amp;D</p>	<p>Unterschiedet für und im Namen von: Avery Weigh-Tronix 1000 Armstrong Drive, Falmouth, MN, 56031-1439, USA am 2017-05-08</p> <p>K.Dieret Globaler Leiter von Forschung und Entwicklung</p>	<p>Signé par et au nom de: Avery Weigh-Tronix à 1000 Armstrong Drive, Falmouth, MN, 56031-1439, USA le 2017-05-08</p> <p>K.Dieret Responsable Mondial de la Recherche et du Développement</p>	<p>Ondersteund voor en namens: Avery Weigh-Tronix bij 1000 Armstrong Drive, Falmouth, MN, 56031-1439, VS op 2017-05-08</p> <p>K.Dieret Wereldwijd Hoofd van Onderzoek en Ontwikkeling</p>	<p>Amministrato per conto di: Avery Weigh-Tronix a 1000 Armstrong Drive, Falmouth, MN, 56031-1439, U.S.A. su 2017-05-08</p> <p>K.Dieret Responsabile Globale della Ricerca e Sviluppo</p>	<p>Firmado en nombre de: Avery Weigh-Tronix en 1000 Armstrong Drive, Falmouth, MN, 56031-1439, EE.UU. el 2017-05-08</p> <p>K.Dieret Jefe Global de Investigación y Desarrollo</p>	<p>Firmado en nombre de: Avery Weigh-Tronix en 1000 Armstrong Drive, Falmouth, MN, 56031-1439, EE.UU. el 2017-05-08</p> <p>K.Dieret Jefe Global de Investigación y Desarrollo</p>

## 2 Overview

This manual covers the installation, connections and configuration of the Model 2060 indicator.

The 2060 can connect to USB flash drives, printers, remote displays, computers and other peripheral devices.

**Communications-** Two standard RS-232 with optional third bi-directional serial ports w/selectable output formats – Standard, Broadcast, Transfer Data Module (TDM).

**Standard Connectivity** - USB 9-pin Amp Input/Output Connector.

**Optional Connectivity-** Internal WiFi, Internal ZigBee point to point wireless, RM 110 Bluetooth, RS 232 peripheral interface, Ethernet Transmitter/Receiver, Third RS-232 Port.

**TTL Inputs-** Three programmable inputs (Std, Zero Clear, Hold, or Print).

**Outputs-** Two setpoint outputs, open collector design.

### 2.1 Front Panel and Keys

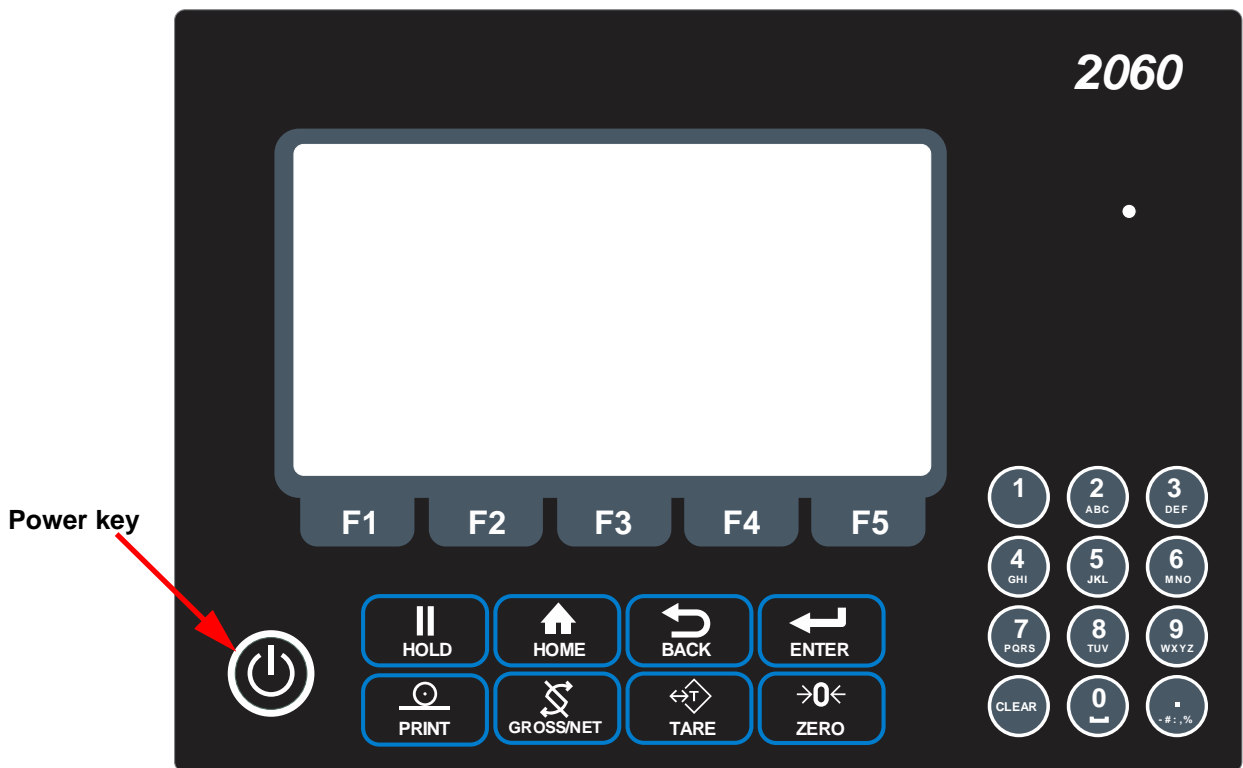

Figure 2.1 2060 Front Panel

Press the **Power** key to turn the unit on and press and hold the key for three seconds to turn the unit off. The display will ask if you are sure. Use the up and down arrow keys to highlight your answer and press the **Enter** (F3) key to confirm.









## 2.1.1 Front Panel Keys

The 2060 front panel shown in [Figure 2.1](#) consists of the keys and the display.



*Never press a key with anything but your finger. Damage to the overlay may result if sharp or rough objects are used.*

The functions of each key on the front panel are listed below.

 <p>TARE</p>	<p>Press to perform a tare function or prompts for a keyboard tare, if enabled.</p>
 <p>ENTER</p>	<p>Press to toggle between Gross, Net, Tare and any other active display values.</p>
 <p>PRINT</p>	<p>Press to send information to a peripheral device (printer, computer or other serial device module).</p>
 <p>HOME</p>	<p>Press in any mode to return to home screen or hold down for 3 seconds to access password screen.</p>
 <p>ZERO</p>	<p>Zeros the scale.</p>
 <p>BACK</p>	<p>Press to back up one screen.</p>
 <p>HOLD</p>	<p>Press to hold a weight.</p>
 <p>GROSS/NET</p>	<p>Press to toggle between the Gross and Net weight.</p>
<p>F1 - F5</p>	<p>Press these keys to select application specific choices.</p>
	<p>Use the numeric keypad to enter numbers and letters in the appropriate screens. Press the <b>CLEAR</b> key to clear the last entry.</p>

## 2.2 Home Screen

---

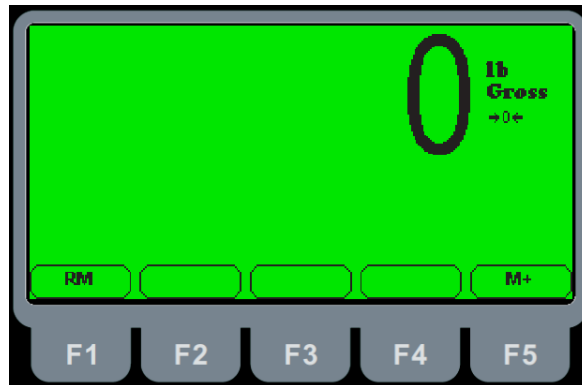

**Figure 2.2 Home Screen**

The home screen has two softkeys, explained below:

**RM (F1)** Press this key to access a memory channel, so the indicator is ready for accumulations into that channel.

**M+ (F5)** Press this key to accumulate weights in the active memory channel.

## 2.3 Adjusting screen contrast

---

To decrease the screen contrast press and hold the **HOLD** key and repeatedly press the **TARE** key. To increase the contrast, press and hold the **HOLD** key and repeatedly press the **ENTER** key.

## 2.4 Using the alphanumeric keypad

---

Use the alphanumeric keypad to enter numbers and words when prompted by the indicator. The action is similar to using a cell phone to select the number or letter. A rapid succession of presses will scroll through the number on the key and then the letters, starting with upper case and then lower case. The decimal key scrolls through the negative sign, pound sign, colon, comma and percent sign. The 0 key toggles between 0 and a space.

## 2.5 Menus

---

Menus used to configure the 2060 are accessed with passwords. See [Menus on page 42](#) for a complete overview of each menu and how to navigate through them.

## 2.6 Standard Print Formats

---

The Model 2060 has 10 available print formats. See the examples below.

### Format 0

```
G: 32010 1b
```

### Format 1

```
G: 32010 1b  
T: 16010 1b  
N: 16000 1b
```

### Format 2

```
04-26-2006  
03:02:47  
G: 32010 1b
```

### Format 3 (default)

```
04-26-2006  
03:02:47  
G: 32010 1b  
T: 16010 1b  
N: 16000 1b
```

### Format 4

```
32010
```

### Format 5

```
32010 , 16010 , 16000
```

### Format 6

```
04-26-2006,03:02:47, 32010
```

### Format 7

```
04-26-2006,03:02:47, 32010 ,  
16010 , 16000
```

### Format 8

```
N: 16000 1b
```

### Format 9

```
04-26-2006  
03:02:47  
N: 16000 1b
```



## 3 Installation

The following section will cover installing the Model 2060 and cable connections.

### 3.1 Mounting the Model 2060

---

The Model 2060 mounts on a quick-detach V bracket or a 1.5" Ram Mount.

#### 3.1.1 Instructions for V mount

---

Weld or bolt the quick-detach bracket into place, as follows:

1. Choose a mounting location that is
  - convenient for operation of the indicator, and
  - protected from moving parts or from other moving machinery
2. Hold the indicator at the proposed mounting location, and verify that the display is legible and the controls accessible.
3. Position the quick-detach bracket with the wider end at the top, mark the desired mounting location. If bolting, use the quick-detach bracket as a template and mark and drill holes.
4. Weld or bolt the quick-detach bracket at the appropriate location. If bolting, use double nuts or self-locking nuts to protect both indicator and machinery. **CAUTION: Do not weld on or near a Weigh Bar. Excessive heat or high currents may cause internal damage.**
5. Insert the indicator bracket into the quick-detach bracket and push it down into place.
6. For mobile applications, wrap and twist a strong wire or zip tie around the indicator bracket and the quick-detach bracket to stabilize the mounting.

#### 3.1.2 Instruction for Ram Mount

---

1. Order the Ram Mount Kit PN AWT05-508626.



2. Take nuts holding V bracket on 2060 off.

3. Bolt one of the 2.5" Ram Mount bases onto the 2060 V mount bracket. It is recommend to bolt the Ram mount onto the Bracket so the V part of the bracket will point towards the 2060 (reverse of how the bracket would be mounted to use as a V mount).

## 3.2 Cable Connections and Power Requirements

---

Voltage to the Model 2060 must be 10-36 volts DC, negative ground only. Dropping below eight volts will cause the Model 2060 to automatically shut itself off, protecting the battery from being completely drained.

### 3.2.1 AWT05-509201 4+ Pin Amp Bottom Plate

---

This model has 4-pin power, Input/Output, printer, remote display and J-box home run cable connector.

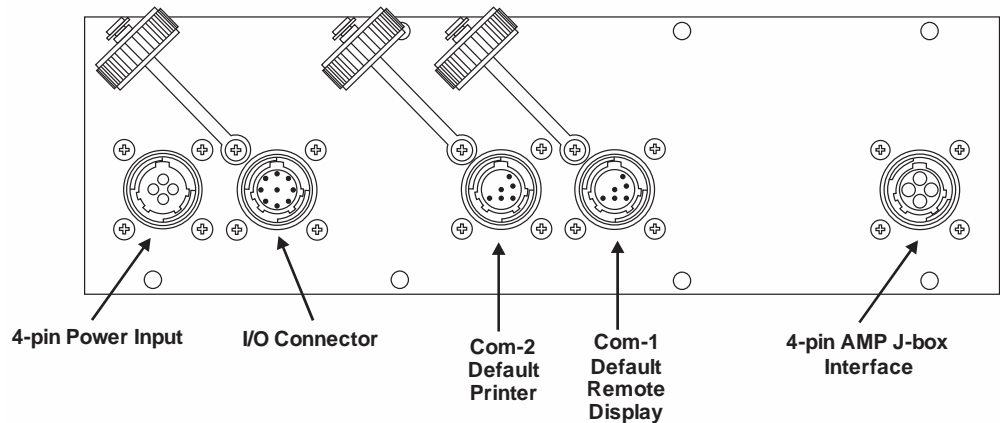

### 3.2.2 AWT05-509202 4x 5Pin AWT Bottom Plate

---

This model has 2-pin power, Input/Output, printer, remote display and input for 4 different weigh bars or J-box home run cable connector.

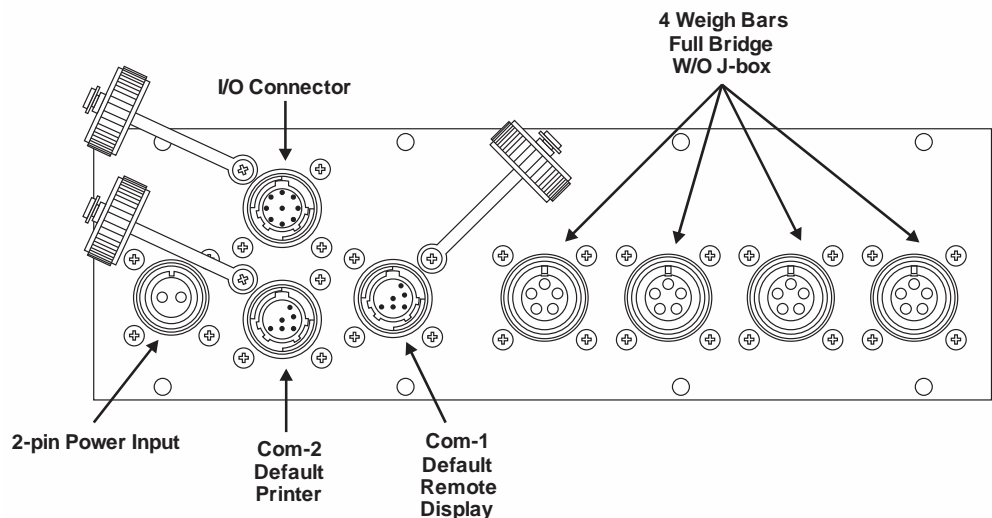

### 3.2.3 Connectors

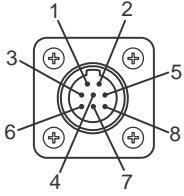
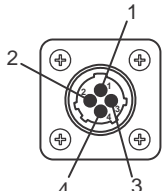
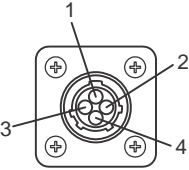
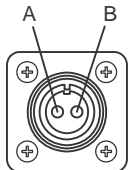
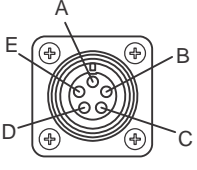
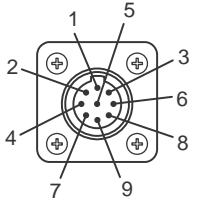
<p style="text-align: center;"><b>RS-232 Port</b></p>  <p style="text-align: center;">Outside View (Male)</p> <table border="1"> <thead> <tr> <th>Pin</th> <th>Description</th> </tr> </thead> <tbody> <tr><td>1</td><td>N/C</td></tr> <tr><td>2</td><td>XMT</td></tr> <tr><td>3</td><td>N/C</td></tr> <tr><td>4</td><td>RXD</td></tr> <tr><td>5</td><td>GND</td></tr> <tr><td>6</td><td>GND</td></tr> <tr><td>7</td><td>+5V</td></tr> <tr><td>8</td><td>+10-36V</td></tr> </tbody> </table>	Pin	Description	1	N/C	2	XMT	3	N/C	4	RXD	5	GND	6	GND	7	+5V	8	+10-36V	<p style="text-align: center;"><b>4-Pin Power Input</b></p>  <p style="text-align: center;">Outside View (Male)</p> <table border="1"> <thead> <tr> <th>Pin</th> <th>Description</th> </tr> </thead> <tbody> <tr><td>1</td><td>+12V Input</td></tr> <tr><td>2</td><td>GND</td></tr> <tr><td>3</td><td>N/C</td></tr> <tr><td>4</td><td>N/C</td></tr> </tbody> </table>	Pin	Description	1	+12V Input	2	GND	3	N/C	4	N/C				
Pin	Description																																
1	N/C																																
2	XMT																																
3	N/C																																
4	RXD																																
5	GND																																
6	GND																																
7	+5V																																
8	+10-36V																																
Pin	Description																																
1	+12V Input																																
2	GND																																
3	N/C																																
4	N/C																																
<p style="text-align: center;"><b>4-Pin Amp J-Box Interface</b></p>  <p style="text-align: center;">Outside View (Female)</p> <table border="1"> <thead> <tr> <th>Pin</th> <th>Description</th> </tr> </thead> <tbody> <tr><td>1</td><td>+ Excitation</td></tr> <tr><td>2</td><td>- Bridge</td></tr> <tr><td>3</td><td>+ Bridge</td></tr> <tr><td>4</td><td>-Excitation</td></tr> </tbody> </table>	Pin	Description	1	+ Excitation	2	- Bridge	3	+ Bridge	4	-Excitation	<p style="text-align: center;"><b>2-Pin Power Input</b></p>  <p style="text-align: center;">Outside View (Female)</p> <table border="1"> <thead> <tr> <th>Pin</th> <th>Description</th> </tr> </thead> <tbody> <tr><td>A</td><td>+12V</td></tr> <tr><td>B</td><td>GND</td></tr> </tbody> </table>	Pin	Description	A	+12V	B	GND																
Pin	Description																																
1	+ Excitation																																
2	- Bridge																																
3	+ Bridge																																
4	-Excitation																																
Pin	Description																																
A	+12V																																
B	GND																																
<p style="text-align: center;"><b>5-Pin Weigh Bar Input</b></p>  <p style="text-align: center;">Outside View (Female)</p> <table border="1"> <thead> <tr> <th>Pin</th> <th>Description</th> </tr> </thead> <tbody> <tr><td>A</td><td>- Bridge</td></tr> <tr><td>B</td><td>+ Excitation</td></tr> <tr><td>C</td><td>+ Bridge</td></tr> <tr><td>D</td><td>- Excitation</td></tr> <tr><td>E</td><td>Shield</td></tr> </tbody> </table>	Pin	Description	A	- Bridge	B	+ Excitation	C	+ Bridge	D	- Excitation	E	Shield	<p style="text-align: center;"><b>I/O Connector (9 pin)</b></p>  <p style="text-align: center;">Outside View (Male)</p> <table border="1"> <thead> <tr> <th>Pin</th> <th>Description</th> </tr> </thead> <tbody> <tr><td>1</td><td>+12V</td></tr> <tr><td>2</td><td>+5V</td></tr> <tr><td>3</td><td>GND</td></tr> <tr><td>4</td><td>Input 2 (ZERO)</td></tr> <tr><td>5</td><td>Input 3 (RESET target)</td></tr> <tr><td>6</td><td>GND</td></tr> <tr><td>7</td><td>Output 1</td></tr> <tr><td>8</td><td>Output 2 (N.O)</td></tr> <tr><td>9</td><td>Input 1 (TARE)</td></tr> </tbody> </table>	Pin	Description	1	+12V	2	+5V	3	GND	4	Input 2 (ZERO)	5	Input 3 (RESET target)	6	GND	7	Output 1	8	Output 2 (N.O)	9	Input 1 (TARE)
Pin	Description																																
A	- Bridge																																
B	+ Excitation																																
C	+ Bridge																																
D	- Excitation																																
E	Shield																																
Pin	Description																																
1	+12V																																
2	+5V																																
3	GND																																
4	Input 2 (ZERO)																																
5	Input 3 (RESET target)																																
6	GND																																
7	Output 1																																
8	Output 2 (N.O)																																
9	Input 1 (TARE)																																

### 3.3 Routing the Scale Interface Cable

---

The scale interface cable is the cable that runs from the junction box (j-box) to the indicator.



---

*For the AWT05-509201 Single Amp you will need to use a J-box.*

---

*For the AWT05-509202 4 by 5-pin AWT you will only need to use a j-box for systems with 5 or more weigh bars.*

---

1. Loosely connect the scale interface cable to the **SCALE** connector on the indicator.

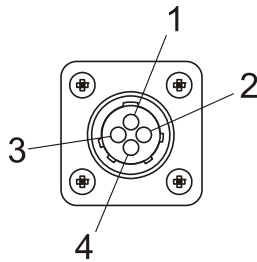

**Scale Connector**

Pin	Description
1	+ Excitation
2	- Bridge
3	+ Bridge
4	- Excitation

**Figure 3.1 Scale Connector**

2. Run the cable from the indicator to the junction box, allowing some slack in the cable.
3. Connect the other end of the scale interface cable to the junction box.
4. Inspect the cable run and make sure that the cable is not pinched, kinked or in the way of moving parts or sharp objects.
5. Be sure to allow some slack when zip tying or tucking away the cable.
6. Tighten the connector at the indicator.

### 3.4 Connecting to a Convenience Outlet

---

If the equipment you are using has an Auxiliary Power Outlet Strip it is preferred to supply power to the indicator from the outlet strip rather than the battery.

Most power strip outlets have spades that provide constant power (unswitched power) or key-switched power. Decide which one works best for your application and identify which spades provide this power type.

If you have a tinned lead power supply and want to connect to the auxiliary power you need to add a spade to each wire.

- Connect the white wire to the key-switched or unswitched power spade.
- Connect the black wire to the ground spade.

### 3.5 Power Connections - Battery

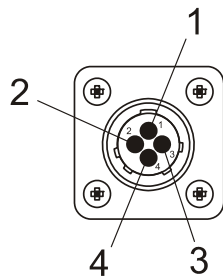

**Power Connector**

Pin	Description
1	+12 VDC
2	Ground
3	N/C
4	N/C

**Available Power Cables**

Part Number	Description
50474-0036	15 ft / 4.6 m power cord, Amp with tinned leads
50474-0051	25 ft / 7.6 m power cord, Amp with tinned leads

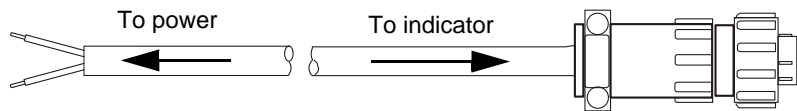

**Figure 3.2 Power Connector and Battery Cable**



*NOTE: Although the above recommends a +12V connection the 2060 specification allows it to be connected to a +36V power system.*



**CAUTION!**  
*This indicator can only be connected to positive power terminal with negative terminal ground battery system.*



*NOTE: The +ve supply is fused inside of the indicator. Ground battery connection means that one terminal of the battery is connected to the equipment metal chassis. The current returns to the battery through the metal work of the equipment chassis.*

1. Disconnect the negative wire from the battery terminal before performing any electrical work.
2. Loosely attach the connector end of the power cable to the 2060 indicator.
3. Route the cable to the desired power source connection point. If possible, run the power cable through existing holes and channels so that it will be out of the way and cannot be damaged by any moving parts. Be sure to keep the cable from running near a distributor cap, the spark plugs or wires, or the alternator on the motor. Keep the cable around the periphery of the engine compartment whenever possible.

4. Pull through all the slack in the cable and cable tie the power cable in appropriate places to hold it in place.
5. Disconnect the power connector from the back of the indicator.



---

**CAUTION:** *Non-approved power connections may damage equipment and void warranty.*

---

- 5a. Crimp the ring terminals (item 1) onto the wires as shown in [Figure 3.3](#) below.
- 5b. Using a heat gun, shrink all of the heat shrink tubing (item 2) in place.

If the battery terminals have bolts to which you can connect the ring terminals, do so. The white wire should be attached to the positive (+) terminal. The black wire should be attached to the negative (-) terminal. Skip to step [9](#)

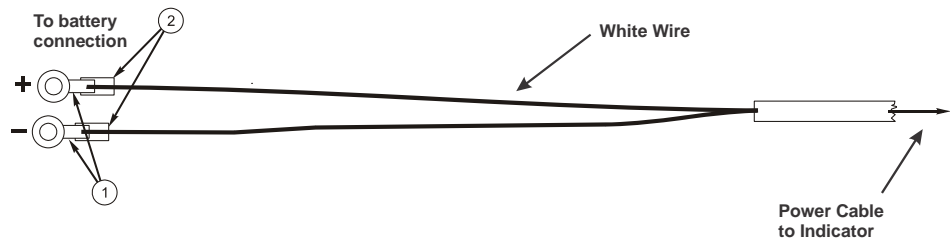

**Figure 3.3 Power Cable Wiring**

6. Connect the white power cable as close as possible to the battery's positive voltage terminal without attaching it directly to the battery terminal. In other words, the first place the positive terminal is connected to is where you should tap in with the white power cable for the instrument.
7. Connect the black ground cable as close as possible to the battery's negative terminal without attaching it directly to the battery. In other words, the first place the negative terminal is connected to is where you should tap in with the black ground cable for the instrument. The chassis may not provide the proper ground potential. Check with the equipment manufacturer to determine if battery ground is isolated from chassis ground.
8. Tighten the AMP or AWT connector on the underside of the indicator. See [figure 3.2](#).
9. Reconnect battery power.
10. Press and hold the **On/Off** key on the 2060 until the red light above the key comes on.
11. Check that the instrument powers on.

## 3.6 Wiring 2060 Indicator to Equipment Power Systems

---

In all cases it is advised that you consult the equipment manufacturer or authorized agents for advice before installing a weighing system. These are configurations that you may find on different equipment manufacturers models.

Note that the electrical connection to the metal work of the equipment is shown by the following symbol:



---

*ENSURE THAT YOU DO NOT SHORT CIRCUIT THE BATTERY; SPARKS AND ARCING FROM A BATTERY SHORT CIRCUIT CAN CAUSE SEVERE BURNS.*

---

- † Always connect to the supply battery terminal last.
- † Complete the wiring to the weighing indicator before connecting to the indicator. Check with a resistance meter to insure there is no connection between the supply wire and chassis ground.
- † Verify battery system you are connecting to has negative ground.
- † When you are satisfied with the above connect to the battery supply.

### 3.6.1 12 Volt Power Systems (one and two 12 V batteries)

---

#### Single Battery

12 V Battery negative terminal ground connection +12V power supply. **DO NOT REVERSE THE POLARITY!**

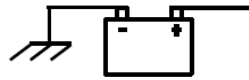

Figure 3.4 Single Battery Connection

#### Two 12 Volt Batteries Wired in Series

Center ground connection +12V power supply

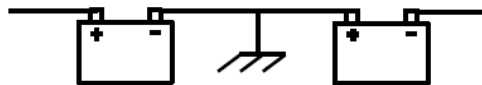

Figure 3.5 Two 12 Volt Battery Connection

## 3.6.2 24 Volt Power Systems

---

The negative terminal connection of the first battery connected to ground, +ve connection wired to the negative terminal of the second battery, the +ve is the +24V power supply. **DO NOT REVERSE THE POLARITY!**



**Figure 3.6 24 Volt Battery Connection**

## 3.6.3 Grounded Power Systems

---

Ground battery connection means that one terminal of the battery is connected to the equipment metal chassis. The current returns to the battery through the metal work of the equipment chassis.

If the power system used is not connected to the chassis ground and is electrically isolated from other equipment then this should not cause any problems with weighing indicators. Normally the indicator is connected to the equipment power supply using one of the grounded power systems described above.

### **Problems Using Chassis Ground**

If the mating parts of the chassis are corroded then the resistance can be high which depending on the current flow may reduce the voltage available to drive accessories.

There may be high power devices such as lights or motors which when switched on or off because they share the current path could cause the voltage available to drive accessories to be electrically noisy. In the case of motors then they can cause very high voltage spikes which could damage accessories.

### **Grounding Weight Indicators**

For weighing indicators it is advised that the one of the power supply inputs is connected to the equipment ground battery terminal through a separate insulated wire.

The separate return wire reduces the risk of chassis corrosion problems and over voltage caused by other equipment electrical systems.

The ground connection ensures that the current flow in the indicator power wires is always in the same direction, so that the built in circuit protection is effective.

If the system described in section 3.6.2 is used then there is available a 12V power connection between 12V and 24 V. If this is used as a 12V power supply connection the following problems could occur;

- † On some indicators the metal housing of the indicator is connected to one of the power connections the 12V from the ground connection. If there is an accidental connection from the indicator housing to the equipment metal work then there will be a large fault current which will cause the power cable 0V wire to heat up.



- † The internal power surge protection in the indicator which protects it, the weigh bars and other components such as external displays will not be effective against over voltages with respect to the ground. This could lead to damage of the weigh bars which are connected by their load connections to the ground although internally electrically isolated. Other accessories such as the external displays, which have metal housings, may also be damaged if there is a high voltage between the power supply and housing.

### 3.7 Power Connections - AC

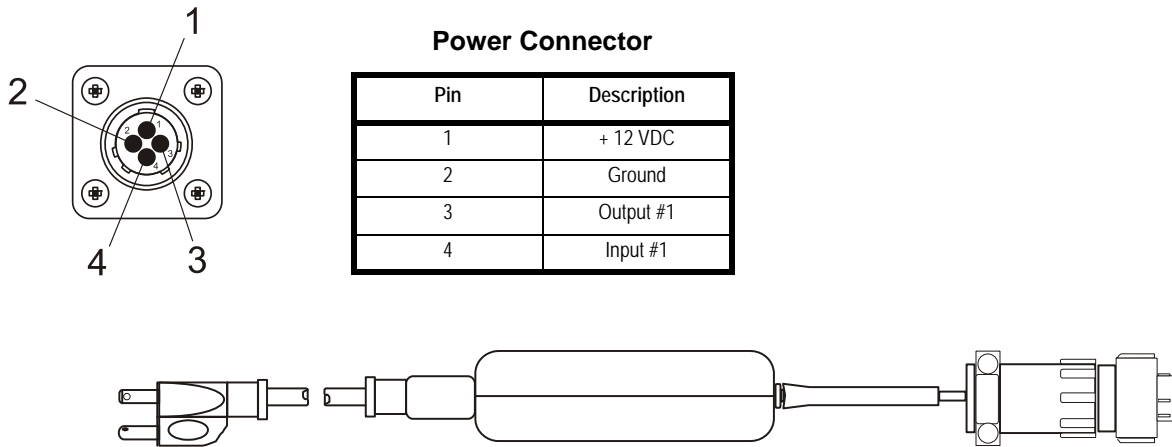

**Figure 3.7 AC Power Connections**

**Table 3.1 AC to DC Cables**

Part Number	Description
AWT15-501422	China AC to DC power converter 12VDC 5A Amp
AWT15-501275	EU AC to DC power converter 12VDC 5A Amp
AWT15-501273	NA AC to DC power converter 12VDC 5A Amp (Replaces 28300-0057)
AWT15-501274	UK AC to DC power converter 12VDC 5A Amp



*Refer to the Ag power supply price sheet for more details on available cables and drawings.*

For applications requiring AC power, follow these instructions.

1. Loosely attach the AC power adapter to the area near the outlet with a cable tie.
2. Route the cable from the electrical outlet to the indicator. If possible, run the power cable through existing channels or conduit so that it will be out of the way and cannot be damaged by any moving parts.
3. Inspect the cable run and make sure that the cable is not pinched, kinked or in the way of moving parts or sharp objects.

4. Tuck or cable tie the excess cable along the run as necessary.
5. Tighten the AMP connector on the underside of the indicator.
6. Plug the AC adapter in to the outlet.
7. Press and hold the **On/Off** key on the 2060 until the red light above the key comes on.
8. Check that the indicator powers on.

### 3.8 Optional Communications Connections

The 2060 comes with two standard and a third optional serial communications (COM) ports which can be used for various peripheral equipment such as a the XLR Series remote displays, printer, RM200 or other device. Use the following instructions for connecting a serial peripheral device to the 2060.



*All COM ports on the 2060 indicator have the same pinouts as shown in Figure 4.11. COM 1 is configured for XLR Series Remote Displays, COM 2 is configured for Printer COM 3 Selectable default settings for each port are: Baud: 9600, Data Bits:8, Parity: None, Stop Bits:1, C-trol: None.*

*Contact your Avery Weigh-Tronix representative if you need to change these settings.*

1. Disconnect the indicator and peripheral device from the power source.
2. Loosely connect the communications cable (serial cable) to the required COM port.

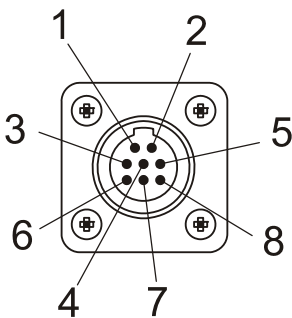

COM Port	
Pin	Description
1	N/C
2	XMT
3	N/C
4	RXD
5	GND
6	GND
7	+5 V
8	+8 V

**Figure 3.8 Sample COM Port**

3. Route the serial cable to the peripheral device using existing channels or conduit whenever possible.
4. Connect the serial cable to the device.
5. Inspect the cable run and make sure that the cable is not pinched, kinked or in the way of moving parts or sharp objects.
6. Tighten the connector at the indicator.

7. Reconnect power to the indicator and device.
8. Press and hold the **On/Off** button on the 2060 until the red light comes on and the indicator powers on.

### 3.8.1 Additional Connectors

The 2060 also has the following connectors:

- † USB connector - located on the right side of the enclosure. Use the USB connector to connect a USB keyboard or flash drive.
- † Ethernet connector - Standard internal with optional port on bottom plate. This port is application dependent

Your scale is now installed and ready for use. If you have any questions during installation, please contact your local Avery Weigh-Tronix representative.

### 3.8.2 I/O Connector Pins (9 pin connector)

Connector / Pin	Description	Wire Color
P12-1	+12V	BLK
P12-2	+5V	BRN
P12-3	GND	RED
P12-4	Input 2 (ZERO)	ORN
P12-5	Input 3 (RESET Target)	YEL
P12-6	GND	GRN
P12-7	Output-1 (GND signal output once Alarm light is engaged)	BLUE
P12-8	Output-2 (currently not used)	GRAY
P12-9	Input 1 (TARE)	VIOLET

**Example: External wiring to RESET Target weight:**

To activate and RESET Target amount, connect the yellow and RED wire.

**Example: External Wiring to turn off Target (auger/Conveyor):**

Connect to the Blue Wire (Gnd Output) and BLACK (+12V) to turn on 12 volt relay

## 4 Quick Start Calibration Guide

This Quick Start Guide includes calibration details for AWTX Weigh Bars standard configuration or Custom configuration, and custom configuration for other brands of Weigh Bars.

### 4.1 Calibrate the 2060 with a Standard Configuration Number

---

This section covers the standard calibration process for the scale system using pre-calibrated Avery Weigh-Tronix weigh cells. If using other brands of weigh cells or configurations of AWTX weigh cells not mentioned below you will need to use Custom Configuration. Refer to section 4.2 for an example of Custom Configuration and Custom Configuration table.

#### 4.1.1 Determine the Configuration Number

---

This section shows you how to find and enter a configuration number that sets up the indicator for the following: type of Weigh Bar calibration diameter, capacity, increment, and units.

The following are instructions for determining what number needs to be entered into the calibration configuration number menu. The calibration diameter (size) establishes the first two numbers for the configuration code. These numbers are on the top center of the label below the heading calibration diameter. In this example the calibration diameter will be 2 1/8.



**Figure 4.1 Sample Weigh Bar Label**

Example:

All standard configuration numbers consist of five digits. Follow the example below.

1st & 2nd digit = Calibration Diameter

3rd Digit= Capacity and increment (Division) size. *Note that capacity refers to the max weight the scale will display not the actual capacity of the equipment that scale system is installed on.*

4th Digit= 0 (Print format will always be 0 for 2060)

5th Digit= Selection of Pounds (0) or Kilograms (4)

**2 1/8 calibration diameter, 20,000 (capacity limit) x 5 (increments the scale counts in), Print format is always 0, unit = lb.**

**Configuration code = 05204**

- The first two digits are the calibration size. In our example the calibration size is **2 1/8**. The corresponding number is found in Table 4.1 on page 30. Find the desired calibration size. In this example, **05** are the first two digits.

1st & 2nd Digits	CALIBRATION SIZE	CAPACITY X INCREMENT SIZE					
03	1-7/8	20K x 1	20K x 2	20K x 5	200K x 10	200K x 20	200K x 50
04	2	20K x 1	20K x 2	20K x 5	200K x 10	200K x 20	200K x 50
05	2-1/8	20K x 1	20K x 2	20K x 5	200K x 10	200K x 20	200K x 50
06	2-1/4	20K x 1	20K x 2	20K x 5	200K x 10	200K x 20	200K x 50

**Figure 4.2 1st and 2nd Digit (Calibration Size)**

- The third digit is the capacity and increment (division) size within the calibration size. In this example **20,000 x 5** is being used. The corresponding number is also found in Table 4.1. Follow the row of the chosen calibration size (i.e. 05) until you find the desired capacity and increment size. Follow the column down to the bottom row. The third digit is located on the bottom row. For this example, **2** is the number.

1st & 2nd Digits	CALIBRATION SIZE	CAPACITY X INCREMENT SIZE					
03	1-7/8	20K x 1	20K x 2	20K x 5	200K x 10	200K x 20	200K x 50
04	2	20K x 1	20K x 2	20K x 5	200K x 10	200K x 20	200K x 50
05	2-1/8	20K x 1	20K x 2	20K x 5	200K x 10	200K x 20	200K x 50
06	2-1/4	20K x 1	20K x 2	20K x 5	200K x 10	200K x 20	200K x 50
	3rd DIGIT	0	1	2	3	4	5

**Figure 4.3 3rd Digit (Capacity and Increment Size)**

- The fourth digit is for print formats. The 2060 print formats are determined by the application so the 4th digit will always be **0**.
- The 5th digit solely selects lb or kg in this example we want kg so the 5th digit becomes **4**. Auto-loc, or Auto-acc is determined by the application software.

## 4.1.2 Configuration Codes

The following tables show how to establish a Configuration Code Number (CCN) to configure the 2060 indicator. Table 4.1 applies to all 3 Weigh Bar junction box systems and 4 Weigh Bar junction box systems.

- † The only exception is the Calibration Size 2 1/4D-P, which can be used with 8 Weigh Bars that are 2 1/4 D cal size.
- † If you use any other number of Weigh Bars, use custom settings 97, 98, or 99 and refer to section 4.2 to find your configuration numbers based on reading of .4mV/V.

**Table 4.1 1st/2nd (Weigh Bar Size) and 3rd CCN Digits (Capacity and Increment)**

1st and 2nd Digit	CALIBRATION SIZE	CAPACITY x INCREMENT SIZE					
00	5/8	200 x 0.01	200 x 0.02	200 x 0.05	2K x 0.1	2K x 0.2	2K x 0.5
01	1	2K x 0.1	2K x 0.2	2K x 0.5	20K x 1	20K x 2	20K x 5
02	1-1/4	2K x 0.1	2K x 0.2	2K x 0.5	20K x 1	20K x 2	20K x 5
03	1-7/8	20K x 1	20K x 2	20K x 5	200K x 10	200K x 20	200K x 50
04	2	20K x 1	20K x 2	20K x 5	200K x 10	200K x 20	200K x 50
05	2-1/8	20K x 1	20K x 2	20K x 5	200K x 10	200K x 20	200K x 50
06	2-1/4	20K x 1	20K x 2	20K x 5	200K x 10	200K x 20	200K x 50
07	2-1/4D	20K x 1	20K x 2	20K x 5	200K x 10	200K x 20	200K x 50
08	2-1/4D-P	200K x 10	200K x 20	200K x 50	200K x 100	200K x 200	200K x 500
09	2-1/2	20K x 1	20K x 2	20K x 5	200K x 10	200K x 20	200K x 50
10	3-1/8	200K x 10	200K x 20	200K x 50	200K x 100	200K x 200	200K x 500
11	4	200K x 10	200K x 20	200K x 50	200K x 100	200K x 200	200K x 500
12	CC20/CC30	20K x 1	20K x 2	20K x 5	200K x 10	200K x 20	200K x 50
13	Alley Weigh	2K x 0.1	2K x 0.2	2K x 0.5	20K x 1	20K x 2	20K x 5
14	CC30-3	20K x 1	20K x 2	20K x 5	200K x 10	200K x 20	200K x 50
15	Chute Weigh	20K x 1	20K x 2	20K x 5	200K x 10	200K x 20	200K x 50
16	CC-50	200K x 10	200K x 20	200K x 50	200K x 100	200K x 200	200K x 500
18	SPARE	20K x 1	20K x 2	20K x 5	200K x 10	200K x 20	200K x 50
20	1-digi	2K x 0.1	2K x 0.2	2K x 0.5	20K x 1	20K x 2	20K x 5
21	1 POLY(DIGI)	20K x 1	20K x 2	20K x 5	200K x 10	200K x 20	200K x 50
22	1-7/8,2(DIGI)	20K x 1	20K x 2	20K x 5	200K x 10	200K x 20	200K x 50
23	2-1/8,2-1/2,2-7/8,3-3/4 (DIGI)	20K x 1	20K x 2	20K x 5	200K x 10	200K x 20	200K x 50
97	Custom Setting	200 x 0.01	200 x 0.02	200 x 0.05	2K x 0.1	2K x 0.2	2K x 0.5
98	Custom Setting	20K x 1	20K x 2	20K x 5	200K x 10	200K x 20	200K x 50
99	Custom Setting	200K x 100	200K x 200	200K x 500	-	-	-
	<b>3rd DIGIT</b>	<b>0</b>	<b>1</b>	<b>2</b>	<b>3</b>	<b>4</b>	<b>5</b>

The fourth digit is for print formats. The 2060 print formats are determined by the application so the 4th digit will always be 0.

**Table 4.2 4th CCN Digit (Print Format)**

4th Digit	Print Formats
	0

The 5th digit selects the calibration unit; lb (0) or kg (4).

**Table 4.3 5th CCN Digit (Calibration Unit)**

5th Digit	Units
0	lb
4	kg

### 4.1.3 Enter the Configuration Code Number Parameter (Cfg Num)

1. From the home screen, press and hold the  key for three beeps (3 seconds), then release. The password screen will be displayed.
2. Enter the password **3088** within 5 seconds and press the **F3/ ↵**. **Busy** will be displayed briefly and the calibration menu will be accessed.
3. The **Calib** menu will be highlighted.
  - † If you have Avery Weigh-Tronix Ag Weigh Cells you can chose between standard and custom calibration codes to calibrate your system.
  - † If you are using weighs from a different manufacturer you will want to go to section [4.2](#) for custom calibration.
4. Press **F3/ ↵**. **Scale 1** will be highlighted.
5. Press **F3/ ↵**. The calibration choices will be displayed.
6. From **Scale 1 Calib** screen, use the **F1/ ▲** or **F2/ ▼** to highlight **Cfg Num**.
7. Press the **F3/ ↵** key.
8. Enter the calibration number and press the **F3/ ↵** key. The **Scale 1 Calib** screen will be displayed.
9. To save and exit, press the **BACK** key until **SAVE SETTINGS** screen is displayed. **SAVE no** will be the first choice displayed.

10. Press the **F2/ ▼** key to scroll to **SaveYes**. Press the **F3/ ←** key to accept and save the configuration number. **Busy** will be displayed. The number will be saved and the display will return to the home screen.



---

*If attempting to enter an invalid number display will show CAN't and return to CONFIG.*

---

#### 4.1.4 Configuration Code Numbers for Common Applications:

##### **SEED TENDERS & TMR MIXERS:**

2 1/8 inch calibration weigh bar	20,000 x 5 lb	(05200)
2 1/2 inch calibration weigh bar	200,000 x 10	(09300)
2 1/4D calibration weigh bar	200,000 x 10 lb	(07300)
CC-30 Compression Cell	200,000 x 10 lb	(14300)

##### **GRAIN CARTS:**

2 1/4D calibration weigh bar	200,000 x 20 lb	(07400)
CC-30 Compression Cell	200,000 x 20 lb	(14400)

If it is impossible to know exactly which weigh bars are on the scale system, try one of the recommended Configuration Code Numbers and keep entering the recommended code numbers until the scale appears to be weighing properly. (See section 4.2.4: *Enter Configuration Code Number (Cfg Num)*).

After several attempts at a code number, if the scale still does not weigh properly please consider the following:

- † Contact your dealer or distributor where the scale was purchased.
- † Access the Avery Weigh-Tronix website at [www.ag scales.com](http://www.ag scales.com) for more debugging tips.
- † Contact the Avery Weigh-Tronix service department at 1-800-458-7062 for assistance.



## 4.2 Custom Configuration Number for AWTX Weigh Bars

For use with all AWTX Ag Weigh Bars. Two numbers (Configuration Code and Custom Configuration) must be entered into the 2060. Refer to Enter Configuration Code Number (Cfg Num) on page 38.

- † Configuration Code Number (Cfg Num)
- † Custom Calibration Number (Cust.Cfg)

### 4.2.1 Determine Configuration Number

The following are instructions for how to determine what number needs to be entered into the calibration configuration number menu. This selection appears as Cfg Num.

Example:

**6 2 1/2 calibration weigh bars, 200,000 (capacity limit) x 20 (increments the scale counts in), print format 0, kg configuration code = 98404**

- In our example the weigh bars are 2 1/2 calibration. [Figure 4.4: 1st and 2nd Digit \(Custom Setting\)](#) is an excerpt from Table 4.1 on page 30. In this example, **98** are the first two digits.

1st & 2nd Digits	CALIBRATION SIZE	CAPACITY X INCREMENT SIZE					
97	Custom Setting	200 x 0.0 1	200 x 0.0 2	200 x 0.05	2K x 0.1	2K x 0.2	2K x 0.5
98	Custom Setting	20K x 1	20K x 2	20K x 5	200K x 10	200K x 20	200K x 50
99	Custom Setting	200K x 1	200K x 2	200K x 5	-	-	-
	3rd DIGIT	0	1	2	3	4	5

**Figure 4.4 1st and 2nd Digit (Custom Setting)**

- The third digit is the Capacity and Increment Size within the custom setting. In this example **200,000 x 20** is being used. [Figure 4.5: 3rd Digit \(Capacity and Increment Size\)](#) is an excerpt from Table 4.1. Follow the column down to the bottom row. The third digit is located on the bottom row. For this example, **4** is the number.

1st & 2nd Digits	CALIBRATION SIZE	CAPACITY X INCREMENT SIZE					
97	Custom Setting	200 x 0.0 1	200 x 0.0 2	200 x 0.05	2K x 0.1	2K x 0.2	2K x 0.5
98	Custom Setting	20K x 1	20K x 2	20K x 5	200K x 10	200K x 20	200K x 50
99	Custom Setting	200K x 1	200K x 2	200K x 5	-	-	-
	3rd DIGIT	0	1	2	3	4	5

**Figure 4.5 3rd Digit (Capacity and Increment Size)**

- The fourth digit is for print formats. The 2060 print formats are determined by the application so the 4th digit will always be **0**.
- The 5th digit selects the calibration unit; lb (0) or kg (4).

## 4.2.2 Determine Custom Calibration Number

This number will be entered in the **CUSTOM Configuration** parameter which appears as Cust.Cfg in the 2060 menu. In this example we have 6 2 1/2 Cal Size weigh bars. Figure 4.6 is an excerpt from Table 4.4: Custom Number Table.

Example for Custom Configuration:

**6 2 1/2 cal size weigh bars, 200,000 x 20 kg = 38559**

1. First you go down left hand column (Cal Size) in Table 4.4 and find **2 1/2**.
2. Next, in the 2nd column find **6** for 6 weigh bars.
3. The third column **38559** is the custom number.

Cal Size	No. of bars	CUSTOM # (lb/kg)
2 1/2	5	32133
2 1/2	6	38559
2 1/2	7	44986

**Figure 4.6 Custom Configuration Number**

Refer to section 4.2.4 on page 38. Refer to Table 4.4 on page 34 for Custom Number codes.

## 4.2.3 Custom Number Table

**Table 4.4 Custom Number Table**

Cal Size	Number of Bars	Custom # (lb) @.4mV/V	Custom # (kg) @.4mV/V
5/8	1	92.3	41.8
5/8	2	184.5	83.7
5/8	3	276.8	125.5
5/8	4	369	167.4
5/8	5	461.3	209.2
5/8	6	553.6	251.1
5/8	7	645.8	292.9
5/8	8	738.1	334.8
1	1	375.3	170.2
1	2	750.6	340.5
1	3	1126	510.7
1	4	1501.3	681
1	5	1876.6	851.2
1	6	2251.9	1021.5
1	7	2627.2	1191.7
1	8	3002.6	1361.9

Cal Size	Number of Bars	Custom # (lb) @.4mV/V	Custom # (kg) @.4mV/V
1 1/4	1	893	405
1 1/4	2	1785.9	810.1
1 1/4	3	2678.9	1215.1
1 1/4	4	3571.9	1620.2
1 1/4	5	4464.9	2025.2
1 1/4	6	5357.8	2430.3
1 1/4	7	6250.8	2835.3
1 1/4	8	7143.8	3240.4
1 7/8	1	2630	1193
1 7/8	2	5261	2386
1 7/8	3	7891	3579
1 7/8	4	10522	4773
1 7/8	5	13152	5966
1 7/8	6	15782	7159
1 7/8	7	18413	8352
1 7/8	8	21043	9545
2	1	3270	1483
2	2	6540	2967
2	3	9810	4450
2	4	13080	5933
2	5	16350	7416
2	6	19620	8900
2	7	22890	10383
2	8	26160	11866
2 1/8	1	3753	1702
2 1/8	2	7506	3405
2 1/8	3	11260	5107
2 1/8	4	15013	6810
2 1/8	5	18766	8512
2 1/8	6	22519	10215
2 1/8	7	26272	11917
2 1/8	8	30026	13619
2 1/4	1	4613	2092
2 1/4	2	9226	4185
2 1/4	3	13839	6277
2 1/4	4	18452	8370
2 1/4	5	23065	10462
2 1/4	6	27678	12554
2 1/4	7	32291	14647
2 1/4	8	36904	16739

Cal Size	Number of Bars	Custom # (lb) @.4mV/V	Custom # (kg) @.4mV/V
2 1/4Dual	1	9226	4185
2 1/4Dual	2	18452	8370
2 1/4Dual	3	27678	12554
2 1/4Dual	4	36904	16739
2 1/4Dual	5	46130	20924
2 1/4Dual	6	55356	25109
2 1/4Dual	7	64582	29294
2 1/4Dual	8	73808	33479
2 1/2	1	6427	2915
2 1/2	2	12853	5830
2 1/2	3	19280	8745
2 1/2	4	25706	11660
2 1/2	5	32133	14575
2 1/2	6	38559	17490
2 1/2	7	44986	20405
2 1/2	8	51412	23320
3 1/8	1	12955	5876
3 1/8	2	25910	11752
3 1/8	3	38864	17629
3 1/8	4	51819	23505
3 1/8	5	64774	29381
3 1/8	6	77729	35257
3 1/8	7	90684	41133
3 1/8	8	103638	47010
4	1	26523	12031
4	2	53046	24061
4	3	79569	36092
4	4	106092	48122
4	5	132615	60153
4	6	159137	72184
4	7	185660	84214
4	8	212183	96245
Alley Weigh bar	1	389	176
Alley Weigh bar	2	778	353
Alley Weigh bar	3	1167	529
Alley Weigh bar	4	1556	706
Alley Weigh bar	5	1946	882
Alley Weigh bar	6	2335	1059
Alley Weigh bar	7	2724	1235
Alley Weigh bar	8	3113	1412

Cal Size	Number of Bars	Custom # (lb) @.4mV/V	Custom # (kg) @.4mV/V
Chute Weigh bar	1	2630	1193
Chute Weigh bar	2	5261	2386
Chute Weigh bar	3	7891	3579
Chute Weigh bar	4	10522	4773
Chute Weigh bar	5	13152	5966
Chute Weigh bar	6	15782	7159
Chute Weigh bar	7	18413	8352
Chute Weigh bar	8	21043	9545
CC-20/CC-30	1	5634	2555
CC-20/CC-30	2	11268	5111
CC-20/CC-30	3	16901	7666
CC-20/CC-30	4	22535	10222
CC-20/CC-30	5	28169	12777
CC-20/CC-30	6	33803	15333
CC-20/CC-30	7	39437	17888
CC-20/CC-30	8	45070	20444
CC-30-3	1	4000	1814
CC-30-3	2	8000	3629
CC-30-3	3	12000	5443
CC-30-3	4	16000	7257
CC-30-3	5	20000	9072
CC-30-3	6	24000	10886
CC-30-3	7	28000	12701
CC-30-3	8	32000	14515
CC-50	1	8000	3629
CC-50	2	16000	7257
CC-50	3	24000	10886
CC-50	4	32000	14515
CC-50	5	40000	18144
CC-50	6	48000	21772
CC-50	7	56000	25401
CC-50	8	64000	29030





#### 4.2.4 Enter Configuration Code Number (Cfg Num)

1. From the home screen press and hold the **HOME** key for three beeps (3 seconds), then release. The password screen will be displayed.
2. Enter the password **3088** within 5 seconds and press the **F3/ ↵**. **Busy** will be displayed briefly and the calibration menu will be accessed.
3. The **Calib** menu will be highlighted. Press the **F3/ ↵**.key.
  - † If you have Avery Weigh-Tronix Ag Weigh Cells you can chose between standard and custom calibration codes to calibrate your system.
  - † If you are using weighs from a different manufacturer you will want to go to section [4.2](#) for custom calibration.
4. From **Scale 1 Calib** screen press the **F3/ ↵**.key.
5. Use the **F1/ ▲** or **F2/ ▼** to highlight **Cfg Num**.
6. Press the **F3/ ↵** key.
7. Enter the calibration number and press the **F3/ ↵**.key. The **Scale 1 Calib** screen will be displayed.
8. If you are using standard configuration codes proceed to step [8a](#) if you are using a custom code proceed to step [8b](#).
- 8a. To save and exit, press the **BACK** key. The **SAVE SETTINGS** screen will be displayed. **SAVE no** will be the first choice displayed.
- 8b. If you used a Custom Configuration Number that starts with 97, 98, 99, press **F2/ ▼** to highlight **Cust. Cfg** (Custom Configuration) and press **F3/ ↵**
- 8c. Enter the custom number and press **F3/ ↵**.
9. Use the **F1/ ▲** or **F2/ ▼** key to scroll to **SaveYes**. Press the **F3/ ↵** key to accept and save the configuration number.The number will be saved and the display will return to the home screen.

#### 4.2.5 Enter Custom Configuration Number (Cust.Cfg)

This parameter will only be visible if a custom configuration number has been entered previously (starts with 97, 98, 99).

1. From the home screen press and hold the **HOME** key for three beeps (3 seconds), then release. The password screen will be displayed.
2. Enter the password **3088** within 5 seconds and press the **F3/ ↵**. **Busy** will be displayed briefly and the calibration menu will be accessed.
3. The **Calib** menu will be highlighted.
  - † If you have Avery Weigh-Tronix Ag Weigh Cells you can chose between standard and custom calibration codes to calibrate your system.
  - † If you are using weighs from a different manufacturer you will want to go to section [4.2](#) for custom calibration.
4. From **Scale 1 Calib** screen, use the **F1/ ▲** or **F2/ ▼** to highlight **Cust.Cfg**.

5. Press the **F3/**  key.
6. Enter the calibration number and press the **F3/**  key. The **Scale 1 Calib** screen will be displayed.
7. To save and exit, press the **BACK** key. The **SAVE SETTINGS** screen will be displayed. **SAVE no** will be the first choice displayed.
8. Use the **F1/**  or **F2/**  key to scroll to **SaveYes**. Press the **F3/**  key to accept and save the configuration number. The number will be saved and the display will return to the home screen.

#### 4.2.6 Custom Configuration Number Calibration

When using Custom Configuration you must use test weights or verify a load on another scale. Refer to section 4.2.4 on page 38 for instructions on entering the custom number into the calibration menu.

Example:

Grain Cart Scale Shows net weight of 52,500 lbs loaded onto Truck Calibrated Truck Scale shows net weight of 53,800 lbs Current Custom Configuration number 38559

Step 1: Calculate difference in weight between Grain Cart Scale and Truck Scale:  $52,800 - 53,800 = 1,300$  lbs

Step 2: Divide difference by Grain Cart Weight to figure % ( $1,300 / 52,500 = .025$  or 2%)

Step 3: In this case the Grain Cart weight was to low so we need to raise the custom number by 2% ( $38559 \times 1.02 = 39,330.18$ ) We round this to 39,330 and enter this in place of the old custom number 38559

If we where 2% to high we simply would lower the custom number by 2% ( $38,559 \times .98 = 37,787.82$ )

Step 4: Verify if the next load is within 1% of the Calibrated Truck scale. If it is not within 1% you can repeat the process above.

## 4.3 Configuring the 2060 for Other Brand Weigh Bars and Loadcells

---

The 2060 will work with any brand of strain gage based weigh bar or load cell. Once the system is installed, the 2060 will then need to be calibrated using the Configuration Code Number (Cfg Num) and (Cust.Cfg).

### 4.3.1 Custom Calibration Number

---

The Custom Configuration can be accomplished by either of the methods below

- † Use the mv/V information from the weigh bars (Example 1 below)
- † Placing Known Weight on Scale (Example 2 below)

#### Example 1:

Need to calibrate to 4 weigh bars with the following information:

1 weigh bar      2.0 mv/V = 5,000 lb

Therefore 4 weigh bars would be 2.0 mv/V = 20,000 lb for the system.

$$5000\text{lb (weigh bar capacity)} \times 4 \text{ (number of weigh bars)} = \mathbf{20,000}$$

Next is to figure out the custom number per 0.4 mv/V

$$2.0 \text{ mv/V (mv/V of weigh bar)} / 0.4 \text{ mv/V (custom number mv/V)} = \mathbf{5 \text{ mv/V}}$$

$$20,000 \text{ (total capacity of weigh bars)} / 5 \text{ (mv/V answer from above)} = \mathbf{4000}$$

The custom number would be the weight value at 0.4 mv/v or as in this example 4000 lb.

#### OR

The other method is to first enter in the Configuration Code Number (refer to section 4.2.1 for details on how to determine the Configuration Code Number) and then place a known weight on the scale. Record that weight and then figure the scale factor difference from the known weight and the displayed weight. Then this factor needs to be multiplied by the current Custom Number to calculate the new Custom Number.

#### Example 2:

Current Custom configuration Code = 4000

Known Weight Applied                      15,000

2060 Displayed Weight                      10,000

$$15,000 \text{ (Known Weight Applied)} / 10,000 \text{ (2060 Displayed Weight)} = \mathbf{1.5}$$

(Current CUSTOM #) x (Calibration Factor) = (New CUSTOM #)

$$4000 \times 1.5 = \mathbf{6000}$$

Therefore go to the Custom Calibration setting in the SETUP menu and change as needed. Refer to section 4.2.4 on page 38 for instructions on entering the values.





# 5 Menus

## 5.1 Accessing the menus

---

To access a menu, press and hold the **HOME** key and the password entry screen is displayed:

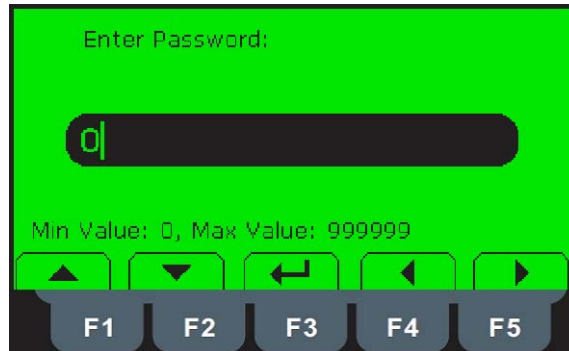

Type in the password for the menu you want and press the **Enter** (F3) key.

Password	Menu Level	Accessed Menus
111	User	User, About, Audit
3570	Diagnostics	Diag, User, About, Audit
1793	Application	Application specific items.
3088	Admin	Setup, Diag, User, About, Audit



---

*The password must be entered within approximately 10 seconds. Otherwise the display will time out and return to the main screen.*

---

See *User menu* [on page 45](#) for information on the User menu.

See *Diag menu* [on page 48](#) for information on the Diagnostic menu.

See *Admin menu* [on page 52](#) for information on the Administrator menu.

See *Application menu* [on page 82](#) for information on the Supervisor menu.

In general, a menu is made up of a group of top level items, sub levels under each of those and lists of items to view or configure. There are variations on this theme. Sometimes there may be no sub level or there maybe two sub levels before you get to a list of items to set.

You will see on-screen lists with instructions on how to choose and set an item in each menu list. On-screen prompts guide you as you move through the menus.

When icons are on screen the bold box around an icon means it is the highlighted icon. See the example below.

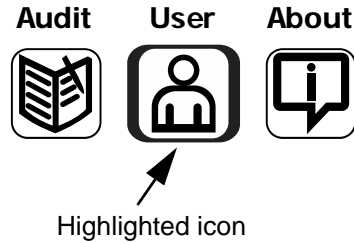

When a text list appears on screen the highlighted item is shown by a bar over the text. See the example below.



### 5.1.1 Menu Navigation

Use the softkeys displayed to move through the menu items. Use the **Enter** key to accept or access a highlighted item. Use the **Esc** key or the **BACK** key to exit a menu or go back one level.

## 5.2 Exiting the Menus

1. From the menu, press the **F1/ ▲** key repeatedly until the following screen is displayed:

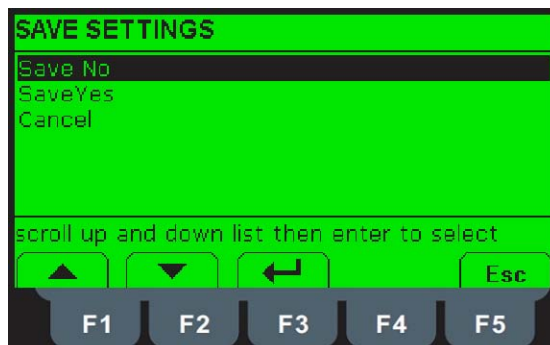

**SAVE no** is highlighted by default.

2. Use the **F1/▲** or **F2/▼** key to highlight your choice:
  - SAVE no** - Do not save changes and exit to the home screen
  - SaveYES** - Save changes and exit to the home screen
  - CAnCEL** - Remain in the menu
3. Press the **F3/↵** key to accept the highlighted choice.

## 5.3 User menu

---

When you access the user menu this screen will appear:



The User menu is made up of three submenus called User, About and Audit. Each are explained below.

### 5.3.1 The User submenu

---

When the User submenu is selected, these choices appear:

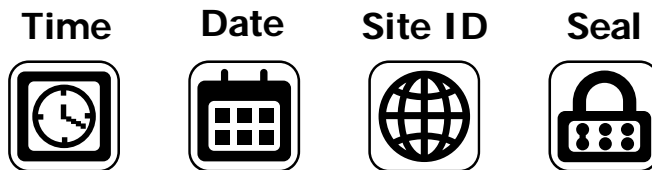

Use the **Left** and **Right** keys to highlight the menu item you want to access and press the **ENTER** key. Each item is explained below.

**Time**      **Set** - Use the numeric keys to enter the correct time in the style chosen below.

**Style** - Choose the style of time display from these choices:

- 12HR - Shows time in the 12 hour style
- 12HR-AP - Shows time in the 12 hour style with AM/PM
- 24HR - Shows time in the 24 hour style



---

*No matter which style you pick, time must always be entered in the 24 hour style. The display of the time will follow the style you pick.*

---

**Date**      **Set** - Use the numeric keys to enter the correct date in the style chosen below.  
**Style** - Choose the style of date display from these choices:

- MMDD2Y
- MMDD4Y
- DDMM2Y
- DDMM4Y



---

*The date format is how the date is stored internally. Printed dates will appear as programmed in the selected print format.*

---

**Site ID**      Use the alphanumeric keys to enter a Site ID, up to six characters.

**Seal**            Shows the status of the physical seal jumper inside the indicator: **SEAL** or **NO SEAL**. If the unit is sealed, no changes can be made to the configuration of the indicator.

You can exit the menu by following the instructions in *Exiting the Menus on page 43*.

### 5.3.2 The About submenu

If you access the About submenu you will see this menu:

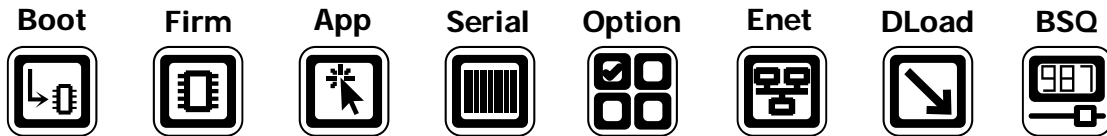

---

**Definitions:**

**Bootloader**    *Software that makes the electronics run.*

**Firmware**      *Embedded system software that creates core functions of the product.*

**App**             *Specific software that controls the behaviour for a given installation.*

---

Use the **Left** and **Right** keys to highlight the menu item you want to access and press the **ENTER** key.

**Boot**            **PartNo** - See the bootloader part number.  
**Version** - See the version of the bootloader.

**Firm**            **PartNo** - See the firmware part number.  
**Version** - See the version of the firmware.

**App**            **PartNo** - See the application part number.  
**Version** - See the version of the application.

**Serial**         See the serial number of the indicator.

**Option**        **Bus 1** - Choose the Bus of the option card. Only one Bus available on the ZK840.  
**Card 1 or 2** - Choose the Card you want to view.

- **Type** - View the type of card.
- **Version** - View the firmware version of the card.

**Enet** This stands for Ethernet. Use this to view the network addresses:

**IP Addr** - See the IP address.  
**Subnet** - See the Subnet address.  
**Gateway** - See the Gateway address.  
**MAC** - See the MAC address.

**DLoad** This stands for download. Use this to view the following:

**sSerial** - View the license number that created the configuration file.  
**dSerial** - View the license number that downloaded the configuration file.  
**dName** - View the company name for the license shown for downloading.

This is used for security and licensing purposes.

**BSQ** Does not apply in this product.

You can exit the menu by following the instructions in [Exiting the Menus on page 43](#).

### 5.3.3 The Audit submenu

If you access the Audit menu you will see this menu:

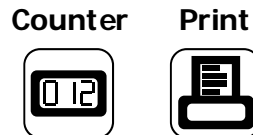

**Counter** **Config** - See the number of configurations the indicator has undergone.  
**Calib** - See the number of calibrations the indicator has undergone.

**Print** Use this to select which port to print the audit report through. The audit report will contain both Config and Calib information. Choices are:

**Port 1** Under **Port 1** choose to print to a column or ticket printer.

**Port 2** Under **Port 2** choose to print to a column or ticket printer.

**USB** Printing to USB requires that a USB flash drive is connected to the indicator host USB. Printing to USB will create a folder on the flash drive and a comma separated file with the data.

You can exit the menu by following the instructions in [Exiting the Menus on page 43](#).

## 5.4 Diag menu

When you access the Diagnostics menu, password 3570, you will see that it consists of the Diagnostics submenu and the previous submenus mentioned earlier: User, About and Audit. This password gains access to another level of the total menu structure.

The diagnostics menu is shown in [Figure 5.1](#). Use this to test or diagnose various functions of the indicator.

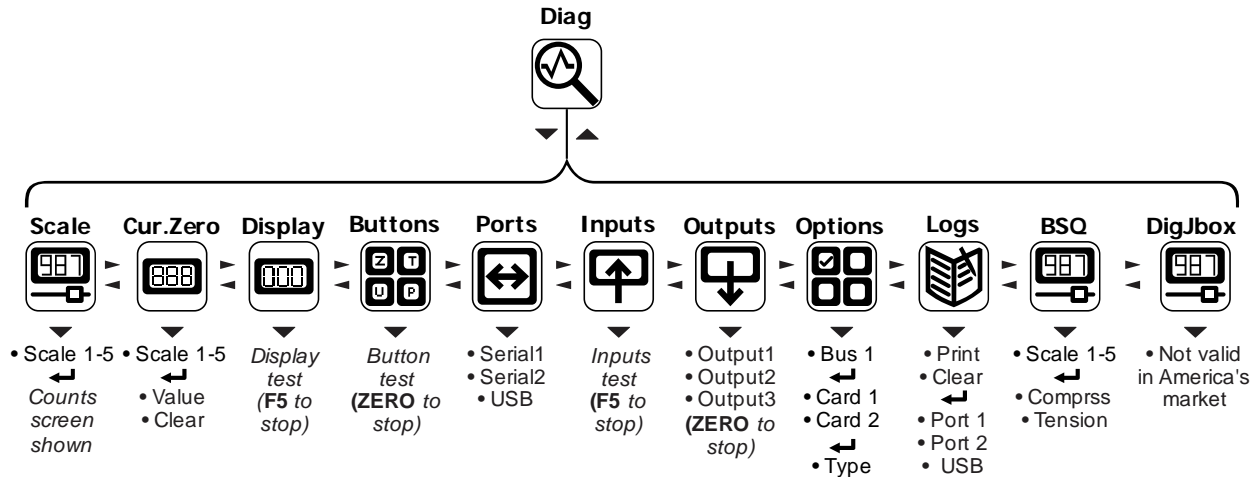

**Figure 5.1** Diagnostics menu map

### 5.4.1 Scale

If more than one scale is installed you can select to view values for Scale 1 through Scale 5.

Press **ENTER** to display the A to D counts. The value is only for diagnostic purposes. The value should increase as weight on the scale increases and decrease as weight decreases.

Press the right arrow key to toggle to a mV/V display. This is an approximate value for the mV/V output of the combined analog load cells of the scale. If the scale is a BSQ you can only view counts, not mV/V.

### 5.4.2 Cur.Zero

**Cur.Zero** This stands for current zero and represents the weight offset between the calibration zero setting and the current zero setting due to pushbutton zero or Auto-Zero Tracking (AZT) adjustments.

Select to view values for Scale 1 through Scale 5, if installed.

**Value** View the zero offset.



**Clear** Clear the zero offset to return the indicator to calibration zero. Choose Yes or No.



---

*This can restore the original calibration zero point if the **ZERO** key is accidentally pressed when a tank or vessel contains product that cannot be emptied.*

---

### 5.4.3 Display

---

Use to test the pixels of the display. The screen lights up in progression for approximately ten seconds or until you press the **SETUP** or **ZERO** key.

### 5.4.4 Buttons

---

Use to test the keys. When you begin the test, **Testing** is briefly displayed followed by dashes.

Press any key to test if it is functioning and its name or value will be displayed.

Press **ZERO** or **SETUP** to stop the test.

### 5.4.5 Ports

---

Use this to do a loopback test for serial port 1 through 2 or to perform a write/read test on the USB port.

**Serial1 to 2** When you pick a serial port to test, **Testing** is briefly displayed and then **Pass** or **Fail**, depending on if the send and receive lines are jumpered (pass) or not (fail). Add a jumper or wire between the transmit output and receive input. On an external 9 pin connector the transmit line is pin 2 and the receive line is pin 3.

If a protocol is setup for a BSQ on the port being tested, it will fail.



---

*It is recommended that you insert the jumper (a paper clip works) into the external cable connector to validate the wiring and not just the internal ports.*

---

**USB** Use this to test a connected USB flash drive.

**Open** is briefly displayed, then **Write** is briefly displayed, then **Read** is briefly displayed, then **Pass** or **Fail**, depending on if the USB device is working correctly or not.

If no USB device is plugged in when you begin the test, **Open** is briefly displayed, then **No USB** is briefly displayed, then **USB**.

### 5.4.6 Inputs

---

The input test is used to verify if external switches wired to the input ports on TB2 are functioning properly.

Follow the steps below to perform the inputs test.

4. Press **SELECT** ...  
*In 000* is displayed, if no inputs are jumpered.
5. To test input 1, jumper pins 1 and 2 of the I/O connector on the indicator ...  
The first digit becomes **1** until the jumper is removed.
6. To test input 2, jumper pins 1 and 3 of the I/O connector on the indicator ...  
The second digit becomes **2** until the jumper is removed.
7. To test input 3, jumper pins 1 and 4 of the I/O connector on the indicator ....  
The third digit becomes **3** until the jumper is removed.
8. Press **ENTER** ...  
*Inputs* is displayed.

### 5.4.7 Outputs

The output test is used to verify if external relays or lights (etc.) connected to TB2 are properly wired and functioning properly.

Follow the steps below to perform the output test.



---

***CAUTION: Be sure to take proper precautions to ensure material controlled by the scale outputs will not create a hazardous condition during an output test.***

---

1. With *Outputs* displayed, press **SELECT** ...  
*Output1* is displayed.
2. Press **SELECT** ...  
**o.1-Off** is displayed.
3. Press **PRINT** or **UNITS** to toggle the output **on (o.1-on)** and repeat to turn it **Off**.  
  
Output 1 will be toggled on and off as you press the keys. This is shown by the annunciator (*SP1*) on the display turning on and off.
4. Press **ENTER** or **F1** to stop the test ...  
*Output1* is displayed.
5. Press **UNITS** to go to the next output. Repeat the steps to test output 2 and 3.
6. When finished, press **TARE** ...  
*Outputs* is displayed.

### 5.4.8 Options

Use this to see the name of installed option cards.

**Bus 1** Refers to Bus 1, where the option card is attached.

**Card 1 or 2** Refers to the position of the S1 switches on the option card.

#### 5.4.9 Logs

---



---

*The logs report will be a printout of overloads and underloads that have occurred.*

---

**Logs** These are logs of overload and underload conditions experienced by the scale. You can print them or clear them from memory.

**Print** Choose to print the log from Port 1, Port 2 or USB.

**Clear** Choose to clear the log from memory.

#### 5.4.10 BSQ

---

Not applicable in this product.

#### 5.4.11 DigJbox

---

Not applicable in this product.

This completes the Diag menu. To exit the menu, see *Exiting the Menus* on page 43.

## 5.5 Admin menu

The Administrator's menu (ADMIN), shown in Figure 5.2, gives the password holder access to Setup, Diagnostic, User and Audit menus. The password is 3088. Since the Diagnostic, User and Audit menus have been explained in previous chapters, this chapter will cover the Setup menu.

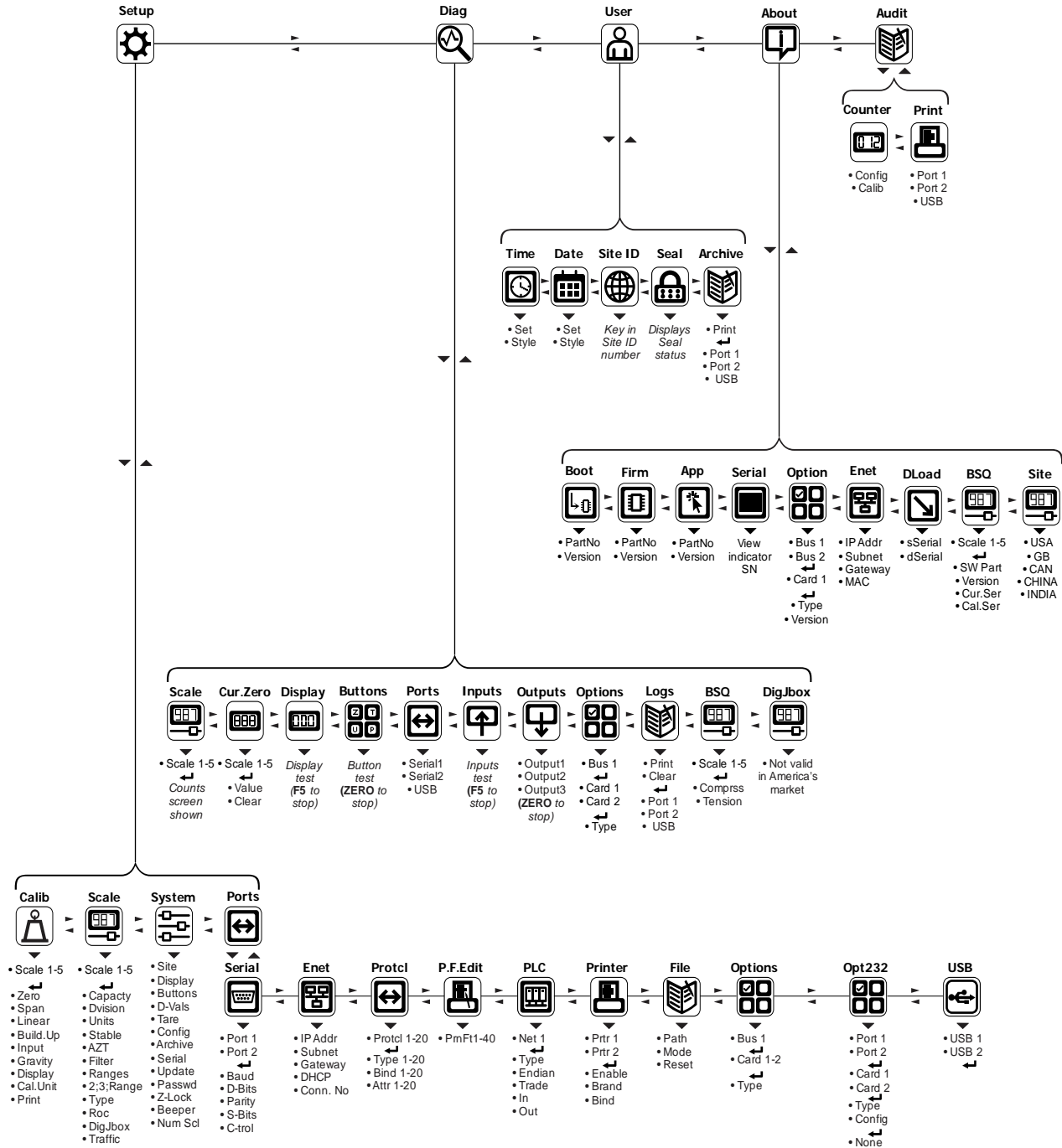

Figure 5.2 ADMIN menu map

1. Press and hold the **SETUP** key to access the password screen.
2. Key in the ADMIN menu password, 3088, and press the **ENTER** key ...

You will see the top level of the ADMIN menu. See [Figure 5.3](#).



**Figure 5.3 ADMIN menu top level**

3. Highlight the Setup icon and press **ENTER** ...

The top level of the Setup menu is displayed. Follow the normal navigation rules to move through the items in this menu. Each item is explained below. See [Figure 5.4](#).

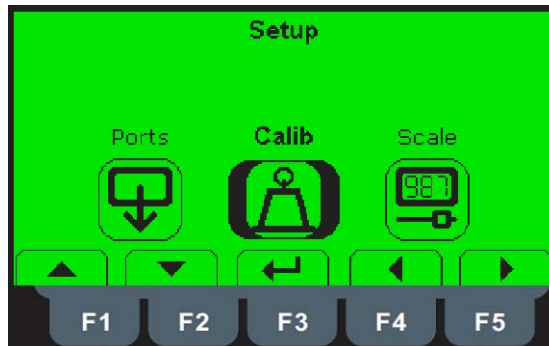

**Figure 5.4 Setup menu top level**

## 5.6 Calibrate

Under **Calib** you first must choose which scale to calibrate. If there is only one scale connected, **Scale 1** is the only choice displayed. There can be up to five scales.

Highlight the scale you want to calibrate and press **ENTER**.

The list of procedures available appears, as shown in [Figure 5.5](#).

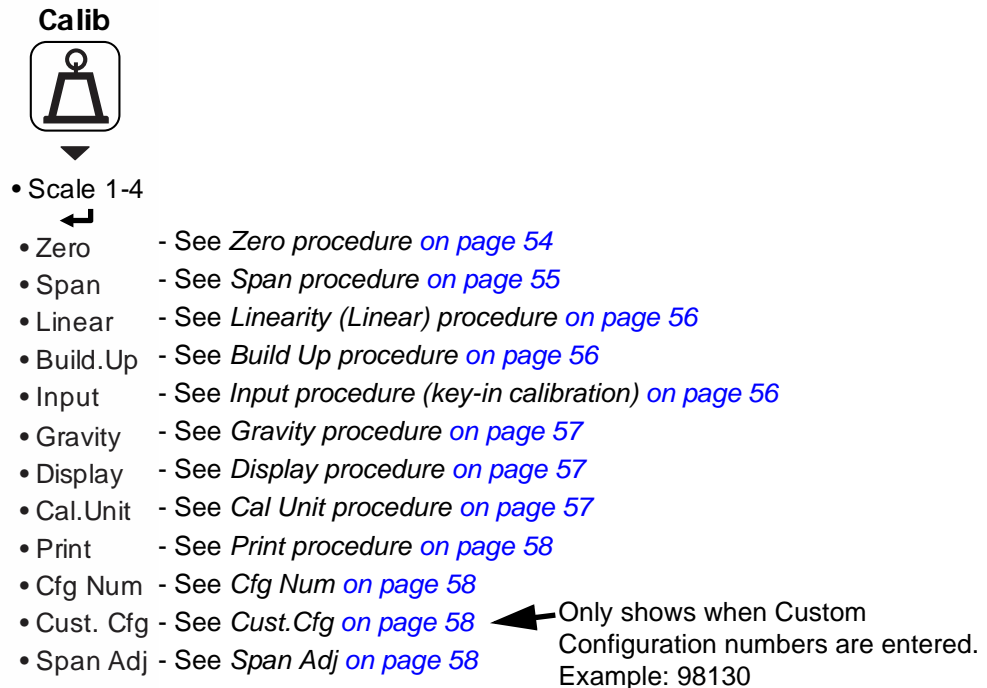

**Figure 5.5 Calibration menu**

### 5.6.1 Zero procedure

Highlight **Zero** to set the zero point for the scale and press **ENTER**

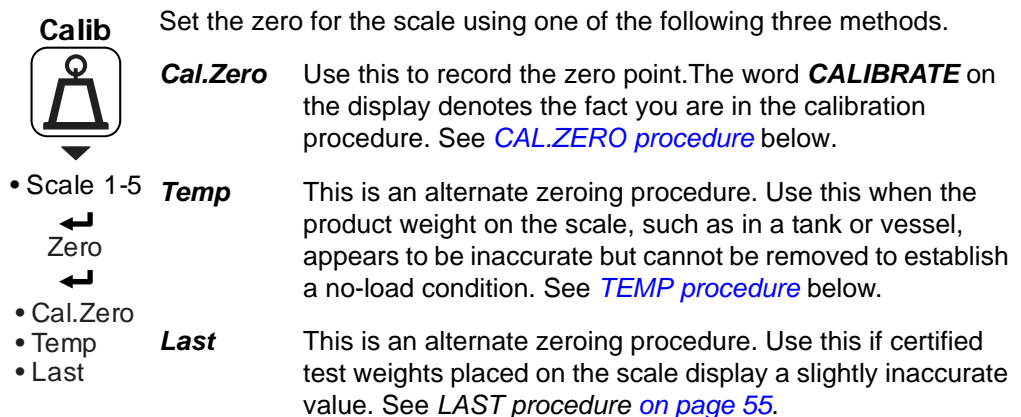

## **CAL.ZERO procedure**

---

1. Highlight **Cal.Zero** and press **ENTER** ...  
The **CALIBRATE** window appears.
2. Empty the scale and press **ENTER** ...  
**Busy** is briefly shown then the weight is displayed.
3. Press **ENTER** to accept the zero point calibration.



---

*On the initial zero calibration of the indicator to a new scale, the zero cal counts may appear unstable. Continue to the span calibration and when completed the condition should correct itself.*

---

## **TEMP procedure**

---

1. Highlight **Temp** and press **ENTER** ...  
The current weight on the scale will be temporarily assigned as the Cal Zero value.
2. Continue to the SPAN procedure, key in the value of the test weights and place them on the scale and complete the SPAN procedure. The original Cal Zero is restored after exiting the span procedure and the current product weight will now be correctly represented. Due to factors that created the original inaccuracy, it may be necessary to re-zero the scale when the tank or vessel is empty.

## **LAST procedure**

---

1. Highlight **Last** and press **ENTER** ...  
The last acquired zero value will be assigned as the new Cal Zero value.
2. Continue to the SPAN procedure without removing the test weights. Key in the value of the test weights on the scale and complete the SPAN procedure. The test weights will now read accurately.

## **5.6.2 Span procedure**

---

When you access the Span procedure the screen will show the current calibration weight value.

1. You can enter a new value for the calibration weight and press **ENTER** to accept it or press **ENTER** to accept the displayed value ...  
The CALIBRATE screen appears showing the accepted calibration weight value.
2. Place the test weights equal to the calibration weight value on the scale and press **ENTER** ...  
**Busy** is briefly displayed then the CALIBRATE screen with the span weight displayed.

3. Press **ENTER** to accept the span ...

The screen returns to the home calibration screen.

### 5.6.3 Linearity (*Linear*) procedure

When you access the **Linear** procedure the screen will show a list of points numbered 2-9. Use these to improve the linearity performance of the scale. The points are numbered 2 through 9 because, internally, the zero reference point is point 1 and the span point is point 10.

Follow the same steps as described in the SPAN procedure to enter each linearity point.

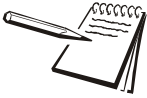

---

*Linearity points are cleared if a new span calibration is performed.*

---

### 5.6.4 Build Up procedure

This procedure means you calibrate in incremental steps in place of doing a full span, as in section 6.1.2. If you enter a weight for cal Pt. 4 then all calibration points above that, i.e. Pt. 5 for example, will be cleared. You can enter a lower weight value in a higher numbered point and the scale will sort the Pts automatically to appear as shown below:

ZERO - 0 lbs

Pt. 2 - 10 lbs

Pt. 3 - 40 lbs

Pt. 4 - 30 lbs

Pt. 5 - 50 lbs

### 5.6.5 Input procedure (key-in calibration)

Use this to set the zero and span for an input.

**ZErO** Use this to enter a value for the zero point.

**CountS** Use this to enter a zero point using A to D counts.

**mV** Use this to enter a zero point using a mV/V value.

**SPan** Accept the flashing displayed span weight (**XXXX**) or key in the span weight that corresponds with the span A to D counts or mV/V value.

**CountS** Use this to enter a span using A to D counts.



**mV** Use this to enter a span using a mV/V value.



---

*Multiple points for span, 2 - 10, may be entered.*

*The Span value is the differential value of the actual Calibration Zero and Span count (or mV/V) values.*

---

### 5.6.6 Gravity procedure

Use this item to key in a gravity constant value. If the scale has been calibrated at a different location that has a significantly different gravitational factor than the installation site, and it is not possible to re-calibrate with known test weights, the scale can be adjusted using this gravity factor.

**G-Fact** If you know the local gravitation factor (allowable range is 9.70000 to 9.90000), key it in here  
**OR**  
If you do not know the local gravitation factor but can determine the approximate latitude and altitude of the installation site, then the indicator can calculate the gravity factor from these two values.

**Lat** This stands for latitude. Key in the latitude for the installation site. The valid range is 0 to 90. A positive value works for north or south of the equator.

**Alt** This stands for altitude. Key in the altitude for the installation site. The valid range is 0 to 30,000 ft. (10000 m).

**Calc** This stands for calculate. The indicator calculates the gravity factor and loads this value as the gravity factor.

Be sure to save the changes when you exit the menu and test the accuracy with a known weight.



---

***CAUTION: Verify with local agencies if adjusting the gravity factor is accepted in your area. It may be required that calibration be done with certified weights.***

---

### 5.6.7 Display procedure

Use this to view live scale weight while in the calibration menu. Press **ZERO** to temporarily zero the scale. Press **SCALE** key to exit.

### 5.6.8 Cal Unit procedure

Use this item to set the unit of measure of the weights used during calibration. Choices are **Lb**, **1000 g** or **gr**. For example, if you are using pound weights for calibration, choose **Lb**.

## 5.6.9 Print procedure

Use this to print a calibration report through **Port 1**, **Port 2** or to **USB**. This information can be used in the future to restore calibration (key-in calibration). See *Calibration report on page 66* to view a representation of the printed report.

## 5.6.10 Cfg Num

If you enter a custom configuration number (for example: 98130) under this item, another menu item appears, Cust.Cfg, explained below.

## 5.6.11 Cust.Cfg

To get your custom configuration number that should be entered under this menu item, see the *Custom Number Table on page 34*.

## 5.6.12 Span Adj

If the span is not correct, you can enter a percentage under this item to correct it. For example if the test weight is 2,000 lbs but the display shows 1,900 lbs (5% low), enter 105% under this item to correct.

This completes the Calib menu. To exit the menu, see *Exiting the Menus on page 43*.

## 5.7 Scale menu

---



---

**CAUTION: Be sure you follow all local weights and measures regulations.**

**Some parameters may be set automatically by your choice of SitE in the System menu item.**

---

Use the Scale menu to configure the scale operating parameters such as capacity and division size, etc. See the full list in [Figure 5.6](#).

If more than one scale is attached, first choose which scale to configure. Press **ENTER** to select it and the list shown in [Figure 5.6](#) appears.

- Scale**
- 
- ▼
- Scale 1-5
    - ◀
    - Capacity - See [Capacity on page 59](#)
    - Dvision - See [Dvision on page 59](#)
    - Units - See [Units on page 59](#)
    - Stable - See [Stable on page 60](#)
    - AZT - See [AZT on page 60](#)
    - Filter - See [Filter on page 60](#)
    - Ranges - See [Ranges on page 62](#)
  - 2;3;Range See [2,3 Range on page 62](#)
    - Type - See [Type on page 64](#)
    - Roc - See [Roc on page 64](#)
  - DigJbox - See [DigJbox on page 64](#)
  - Traffic - See [Traffic on page 64](#)

**Figure 5.6 Scale menu**

### 5.7.1 Capacity

This stands for capacity. Access this item and you can key in a new capacity or accept the displayed capacity.

### 5.7.2 Dvision

This stands for division size. Choices are **0.000001, 0.000002, 0.000005, 0.00001, 0.00002, 0.00005, 0.0001, 0.0002, 0.0005, 0.001, 0.002, 0.005, 0.01, 0.02, 0.05, 0.1, 0.2, 0.5, 1, 2, 5, 10, 20, 50, 100, 200** and **500**. The default value is **1**.



---

*Division sizes for other units of measure are automatically calculated by the indicator.*

---

### 5.7.3 Units

Use this to select the units of measure or create custom units.

**Unit** From this item you can choose which units of measure are available when the user presses the **UNITS** key during normal weighing. You can have up to four units for viewing. They are listed as: **Unit 1, Unit 2, Unit 3** and **Unit 4**. You can assign any of the following units of measure to any of the units: **Lb, 1000 g, oz, gr, lb-oz, Cust 1, Cust 2, Cust 3, Cust 4** or **Off**.

**Custom** This stands for custom unit. To use a custom unit you must first create them by entering a ratio and a string to define it.

**Cust 1-4** You can set up one to four custom units. The process to set up a custom unit is the same for all four.

**Ratio** The ratio is the number you divide into the calibration unit of measure to create the custom unit. Example: Ratio would equal 2000 if you wanted to convert pounds to tons.

**String** Use this to enter a string label for the custom unit.

#### 5.7.4 Stable

---

Use this parameter to set the stability window for the scale. Set a division window and a time window which will be used to determine when the stability icon will be displayed.

**Div** Set the division window size to define stability.

**Time** Set the time window in seconds to define stability. Set both **Div** and **Time** to **0** to disable stability.

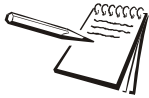

---

The **Stable** time value is used during normal operation as the length of time the indicator will continue to check for a 'motion stable' condition after the **ZERO**, **TARE** or **PRINT** button is pressed. If the intended operation cannot be completed before the timeout, **Cant** may be displayed and the key request is ignored.

---

#### 5.7.5 AZT

---

This stands for Automatic Zero Tracking. The **Div** value defines a  $\pm$  range around zero. When scale weight is not at the center of zero but inside this range for the time value entered,  $\frac{1}{2}$  of the weight will be subtracted. This process is repeated until weight is inside the center of zero region.

**Div** Set the AZT window size to define stability. 1 divisions is the default value. Set **Div** to **0** to disable AZT.

**Time** Set the time window in seconds. 1 second is the default value. Set to **0** to disable AZT.

#### 5.7.6 Filter

---

Use this to filter out vibrations affecting the scale. Under this item you have the following three parameters to set.

**Avg** This stands for average. 15 is the default value.

**Const** This stands for constant. 3 is the default value.

**T-hold** This stands for threshold. When **0** is the threshold value, filtering is always on.

To find the best settings for your filter needs, follow steps **1** to **7**.



---

Default settings are:

AVG = 10

Const = 1

t-hold = 100 (factory default based on 5000 lb capacity)

Values will vary depending on the selected scale capacity, division size and platform type used.

These values will provide the best weight response for the majority of scale installations. In adverse conditions, where wind, vibration or other conditions are affecting the stability of the weight displayed, refer to the following instructions to improve the performance of the indicator.

---

1. Using the Threshold setting is only recommended if the items to be weighed are similar in weight. If the item weights vary considerably then set the threshold value to 0 and proceed to step 2.

To determine the threshold value first set **T-Hold** to 0.0, **Const** to 0, and **Avg** to 1.0. Return to weigh mode and, with a typical item on the scale, observe the weight swings. Record the difference between the highest and lowest displayed weight values. Add 30 to 50% to this value. This is a good starting value for the **T-Hold** setting. Do not set your indicator to this value until told to in step 7.

2. Setting **Avg** to higher values increases the filtering effect.

To do this: Set **T-Hold** to 0.0, **Const** to 0, and **Avg** to 10. Check the stability of the scale by exiting to normal weigh mode, remove all weight from the scale and/or press **ENTER** and observe the Center of Zero annunciator. If it is on all the time your scale is stable. If the Center of Zero light blinks, more filtering is required. Go to step 3.

3. Repeat step 2 but increase **Avg** by 10.

Keep repeating steps 2 and 3 until the scale is stable or you've tried an Average value up to 80. If the scale is still not stable go to step 4.

4. Setting the **Const** to higher values increases the filtering effect.

To do this: Set **T-Hold** to 0.0, **Const** to 1, and **Avg** to 80. Check the stability of the scale by exiting to normal weight mode and observe the Center of Zero annunciator. If it is on all the time your scale is stable. If the Center of Zero light blinks, more filtering is required. Go to step 5.

5. Repeat step 4 but increase the **Const** by 1. Keep repeating steps 4 and 5 until the scale is stable or you've tried the entire range of Constant (10). If the scale is still not stable, decrease your display update rate and start over at step 1 using the new, slower display rate.

6. After the **Const** value is established you may wish to lower the **Avg** value to improve display response time.

7. After a final value for **T-Hold**, **Const** and **Avg** has been set, enter the **T-hold** value established in step 1. If this value is too small your scale will act as if the filtering is off or not working.

Increase the **T-hold** value until your scale stabilizes.

If the Threshold value is too high, your scale will react slowly to weight changes.

When filtering is properly adjusted the scale will be stable at zero and will rapidly display a stable test weight value.

### 5.7.7 Ranges

Use this to set the following ranges.

- O-Rnge** Use this to set the percentage of capacity which can be zeroed off the scale by pressing the **ENTER** key.
- O-Cap** This stands for over capacity. Use this to configure the over/under capacity function of the scale. See the items below.
  - Basis** Use this to choose what the over and under capacity function is based on.
  - Percent** Use this to choose to base over/under capacity on a percent.
  - Div** Use this to choose to base over/under capacity on number of divisions.
  - O-Load** This stands for overload. Once you've picked the basis for an over capacity condition, use this item to set the value that triggers the overload condition.
  - U-Load** This stands for underload. Use this item to set the value that triggers the underload condition.
- G-Zero** Use this to configure the gross zero band. This is a parameter used to perform the tare clear function and set the Return to Zero range for Autoprint, Accumulate, Checkweighing, Counting and Batch functions. You can enter a value between 0 and 10000 divisions.
- P-Zero** This is the percentage of capacity of weight that will be automatically zeroed out on power up. The default setting is +/- 10 percent. The allowable range is from 0 to 100. If set to 0 than no zero will occur on power up. The display will show Z-Error if outside the range or in motion condition is present on power up or when exiting from a SETUP menu. To clear the error remove the weight or motion condition for a stable weight inside the set percentage value.

### 5.7.8 2,3 Range

The indicator can be setup for dual or triple ranging operation using multi-range or multi-interval type division size switching

- Cap 1** CAP 1 is used for both dual and triple range operation. In dual range operation (and increasing weight) values between 0 and **Cap 1** will use **Div 1** as the division size and values above **Cap 1** will use the division size entered in *Division on page 59*.
- Cap 2** CAP 2 is used for triple ranging operation only. In triple range operation (and increasing weight) values between 0 and the **Cap 1** will use **Div 1** as the division size, values between **Cap 1** and **Cap 2** will use **Div 2** as the division size, and values above **Cap 2** will use the division size entered in *Division on page 59*.
- Div 1** This is the division size for the 1st weight range.
- Div 2** This is the division size for the 2nd weight range.
- Type** Use this to choose between Multi Range or Multi Interval. The Type setting determines the condition for switching to a new division size when weight is removed.
- M.Range** Multi-range - the division size will change as it enters a new weight range on increasing weight but will not change back to the smaller division size until the display returns to Zero. This is the default setting. *W1*, *W2* or *W3* annunciators will appear when appropriate.
- M.Intrvl** Multi-interval - the division size will change immediately as it enters a new weight range.

## 5.7.9 Type

---

Use this to select the mode and corresponding binding for the selected scale.

**Mode** Select the mode from these choices:

**Disable** Pick this to disable the selected scale. This is the default setting for Scale 2.

**Option** Pick this mode if you are using the analog scale option card.

**Protcl** Pick this mode if you are using the BSQ base connected to a serial port.

**Bind** This option appears in two different forms depending on which Mode you pick. If you pick **Disable** or **Onboard** in the Mode menu, the **Bind** menu does not appear.

If you choose **Option**, this selection requires a bus and card number. Up to two option cards can be installed.

If you choose **Protcl**, you must choose a binding with a protocol selection. There are 20 available protocols and the protocol number selected must be matched with a properly configured protocol shown in [Protcl on page 75](#).

## 5.7.10 Roc

---

This stands for Rate of Change. Use this to set the parameters to calculate rate of change for flow rates or weight/time applications.

Settings available are:

**Period** Enter a value for the period of time to calculate Roc.

**Units** Enter the units for the time: **Seconds**, **Minutes** or **Hours**.

## 5.7.11 DigJbox

---

This item is not valid in the America's market.

## 5.7.12 Traffic

---

This item is not valid in the America's market.



## 5.8 System menu

---

Use the System menu to configure system parameters such as loading defaults for the country of operation, setting available display modes and tare functions, selection of the scale application mode, and several other functions that will be described. Refer to [Figure 5.7](#) as you setup the items of the System menu.

### System



- Site - See [Site on page 65](#)
- Display - See [Display on page 66](#)
- Buttons - See [Buttons on page 67](#)
- D-Vals - See [D-Vals on page 67](#)
- Tare - See [Tare on page 69](#)
- Config - See [Config on page 69](#)
- Archive - See [Archive on page 70](#)
- Serial - See [Serial on page 70](#)
- Update - See [Update on page 70](#)
- Passwd - See [Password on page 71](#)
- Z-Lock - See [Z-Lock on page 71](#)
- Beeper - See [Beeper on page 71](#)
- Num Scl - See [Num Scl on page 71](#)

**Figure 5.7 System menu**

### 5.8.1 Site

---

Choose your area of operation of the indicator. Choices are: **USA**, **GB**, **CAN**, **EU**, **CHINA** and **INDIA**. This sets the defaults needed for your area when the indicator is reset. See [Default Values](#) below..



---

**CAUTION: Be sure you follow all local weights and measures regulations.**

---



---

To reset the default settings affected by the Site selection, choose an alternate Site selection and press **ENTER**, then re-select the original Site selection.

---

## Default Values

Each area of the world has different requirements for indicator configuration. The table below shows all the default values listed for all the different sites covered by the indicator.

	USA	GB	CAN	EU	CHINA	INDIA
Capacity	70	35	35	35	35	35
Division	0.001	0.0005	0.0005	0.0005	0.0005	0.0005
Cal Weight	70	35	35	35	35	356
Unit of measure	lb	kg	kg	kg	kg	kg
Unit of measure 2	g	g	g	g	g	g
Unit of measure 3	g	g	g	g	g	g
Cal unit	lb	kg	kg	kg	kg	kg
Zero Range	100	2	2	2	2	2
Over Basis	Percent	Division	Percent	Division	Division	Division
Disp. Update Rate	10	20	10	20	10	10
Separator	decimal	decimal	decimal	comma	decimal	decimal
Date Format	MM-DD-YY	DD-MM-YY	DD-MM-YY	DD-MM-YY	DD-MM-YY	DD-MM-YY
Time Format	12 Hr	24	24	24	24	24
Under Cap. Div.	250	20	250	250	250	250
AZT Div.	1	1	1	1	1	3
AZT Time	1	0.5	1	0.5	1	1
Motion Div.	3	.25	3	.25	3	3
Filter threshold	0.1	0.05	0.05	0.05	0.05	0.05



---

*All **bold** items apply to all scales if multiple scales are attached to the indicator.*

---

**Default settings may need to be changed to meet local agency requirements**

### 5.8.2 Display

Use this to set the following parameters for the display.

**Dec.Pt** This configures whether a decimal point or comma is used to separate whole and fractional numbers.

**Update** This configures the number of display refreshes per second. Choices are **1, 2, 5, 10** and **20**.



---

*Lowering the update rate can sometimes improve stability of the display in noisy environments, e.g. vibration or wind.*

---

**M-Dash** If enabled, the display will show dashes during motion.

- C-Zero** Choose the center-of-zero window size to be **0.25** or **0.50** division. If the weight is within this window, the zero annunciator on the display will be lit.
- Tot-Scl** Use this to enable display of the total of both scale weights if two scales are installed and enabled.
- Invert** Inverts the color values of the display. Choose **Off** for green graphics over a black background. Choose **On** for black graphics over a green background.

### 5.8.3 Buttons

---

Use this item to configure each button (key) **On** or **Off**. This allows you to limit the front panel function to suit your situation. Follow the same procedure for each key to turn it on or off. **On** is the default value for all the buttons. These are the keys listed under Buttons: **Print, Scale, Setup, Sample, Tare, and Zero**.

### 5.8.4 D-Vals

---

This stands for the displayable active values. In normal weighing mode, press **SELECT** to scroll through all enabled values. Activate the ones in the following list that you want the ability to view during normal weighing mode.

- Gross** Activate this to see the gross weight value.
- Tare** Activate this to see the tare weight value.
- Net** Activate this to see the net weight value.
- Min** Activate this to see the minimum weight value.
- Max** Activate this to see the maximum weight value.
- G Total** Activate this to see the gross total weight value.
- N Total** Activate this to see the net total weight value.
- T Total** Activate this to see the tare total weight value.
- C Total** Activate this to see the count total value.
- TranCnt** Activate this to see the transaction count value.
- Count** Activate this to see the count value.
- Pc Wt** Activate this to see the piece weight value.
- A2D Cnt** Activate this to see the A to D count value.
- Percent** Activate this to see the percent value.
- InMo** Activate this to see the averaged weight value when an inmotion application is operating.
- Target** Activate this to see the target weight value.
- GTotPls** Activate this to see the gross total + current gross value. This parameter is commonly used in conjunction with the accumulation procedure for multiple-dump batching applications.
- GTotMin** Activate this to see the gross total - current gross value.

- NTotPls** Activate this to see the net total + current net value.
- NTotMin** Activate this to see the net total - current net value.
- CTotPls** Activate this to see the count total + current count value. This parameter is commonly used in conjunction with the accumulation procedure for multiple-dump batching applications based on piece count.
- CTotMin** Activate this to see the count total - current count value.
- Gr Avg** Activate this to see the average gross value.
- Nt Avg** Activate this to see the average net value. The characteristics of the average net parameter are identical to that of the average gross.
- Ct Avg** Activate this to see the average count value. This represents the number of times the gross and net weight were accumulated.
- Nt Min** Activate this to see the net minimum value.
- Nt Max** Activate this to see the net maximum value.
- FFall 1** Activate this to see the free fall 1 value. Free fall is like preact. This is the calculated amount of material that will fall on the scale base on the current flow rate.
- Fut Gr1** Activate this to see the future gross value (#1). This represents a predicted gross weight calculated by multiplying the current rate by the free fall time and adding the result to the current gross weight:
- $$\text{Future Gross} = \text{Rate} \times \text{Free Fall 1} + \text{Gross}$$
- Fut Nt1** Activate this to see the future net value (#1). This represents a predicted net weight calculated by multiplying the current rate by the free fall time and adding the result to the current net weight:
- $$\text{Future Net} = \text{Rate} \times \text{Free Fall} + \text{Net}$$
- FFall 2** Activate this to see the free fall 2 value. Free fall is like preact. This is the calculated amount of material that will fall on the scale base on the current flow rate.
- Fut Gr2** Activate this to see the future gross value (#2). This represents a predicted gross weight calculated by multiplying the current rate by the free fall time and adding the result to the current gross weight:
- $$\text{Future Gross} = \text{Rate} \times \text{Free Fall} + \text{Gross}$$
- Fut Nt2** Activate this to see the future net value (#2). This represents a predicted net weight calculated by multiplying the current rate by the free fall time and adding the result to the current net weight:
- $$\text{Future Net} = \text{Rate} \times \text{Free Fall} + \text{Net}$$
- PcWt 1K** Activate this to see the average piece weight x 1000. The average piece weight x 1000 parameter represents the average weight of 1000 pieces as calculated during the sampling routine.
- Per Acc** Activate this to see the percent accuracy value. The percent accuracy parameter represents the minimum accuracy achieved during the last sample routine. Only one percent accuracy parameter is maintained for all enabled scales.

**Lst Smp** Activate this to see the Last sample size value. The last sample size parameter represents the number of pieces used during the last sample routine to determine the current average piece weight. Only one last sample size parameter is maintained for all enabled scales.

## 5.8.5 Tare

---



---

*Pushbutton and keyboard entry tare can both be set to on simultaneously. The **TARE** key must be enabled in the **Button** menu.*

---

Use this item to set the type of tare entry and the tare autoclear functions.

**PushBt** This stands for pushbutton tare. Enable this to use the **TARE** key to tare weight from the scale. **on** is the default value.

**Enter** This stands for keypad entry tare. Within the Gross Zero Band, press **TARE** and enter the value. **Off** is the default.

**Preset** This stands for preset tare. Preset tare values are entered in a password protected menu and can be recalled, if this parameter is enabled. **Off** is the default value.

**TareCI** This stands for automatic tare clear. Enable this to automatically clear a tare after a weighment when the weight falls into the gross zero band. **Off** is the default value.

**HiRes** This stands for high resolution tare. If On, the indicator does not round the tare value to the current division size. Choose **On** to enable high resolution tare or **Off** to disable high resolution tare. Default is **Off**.



---

*If preset tare is enabled, pushbutton tare and keyboard entry tare will be disabled automatically.*

---

## 5.8.6 Config

---

Use this to print out the configuration data through one of the ports or reset the configuration or calibration to factory defaults. Follow these steps:

**Print** Use this to print the indicator configuration information. You pick the port to use for printing in the following steps. See the extensive list in Chapter 9 - [Printed reports \(page 66\)](#)

Choices are **Port 1**, **Port 2** and **USB** (text file).



---

*If USB is selected, a USB flash drive must be installed to create the text file of the indicator configuration.*

---

**Reset** Under this item you can choose to reset the **App.Cnfg** (reset configuration settings back to how the application had it set when it was last downloaded), **Config** (factory default settings) and **Cal** (factory default calibration) memory or choose **All** to reset both config and cal factory defaults at once.

### 5.8.7 Archive

---

This stands for electronic archive. In other regions it is known as an alibi memory or tally roll. These will be transmitted via configured communications ports. These reports can be used to confirm a weighment if it is ever in dispute. Only records that are qualified as a LEGAL record, per site motion criteria, are considered as entries to this log.



---

*You can configure how many transactions to save when you enable Archive. The default value is 5,000 transactions. The Archive report uses a rolling memory configuration (FIFO - First In First Out) so the oldest transaction will be written over first when all the memory slots are filled.*

---

**Enable** Choose **On** to enable. If enabled, a **Print** menu item appears to the right of **Enable**.

**Print** You can choose to print the archive from Port 1, 2 or to USB. (USB device must be installed).

**File** Choose where the records are saved: Internally, on a USB memory stick or an SD card.

**Limit** Set the total number of allowed records. Default is 5000.

### 5.8.8 Serial

---

Use this to record the serial number of the indicator. The serial number is located on the label attached to the indicator. To enter the serial number enter the first four digits, press **ENTER** and enter the last five digits and press **ENTER** again to accept.

### 5.8.9 Update

---

This menu will allow you to set the conditions for the indicator to accept software updates from a remote site. If connected to a network, the indicator can accept a software update file via Zcom. The software update can be installed manually or automatically when the file is received or on the next powerup.



---

*Manual update selection only applies when AUTO update is disabled and only if a file has been sent via Zcom to the indicator and is waiting to update.*

---

**Manual** Choices under this are **No** and **Yes**. Choose **Yes** to start the update process. Choose **No** to not do an update. **No** is the default.

If you choose **No**, no update occurs and **Manual** is displayed. If you choose **Yes**, the indicator will update and reboot.

**Auto** Choices under this are **on**, **PwrUp** and **Off**. Choose **On** (the default setting) and the indicator will update anytime it receives an update via Zcom. Choose **PwrUp** to have the indicator auto-update on powerup if an update is available. Choose **Off** to turn auto-update off.



---

*If **Auto = Off**, the only way to update the indicator is to use the **Manual** update and select **Yes**.*

---

## 5.8.10 Password

---

Use this to change the password for the **Admin**, **Diag** and **Calib** menus.



---

*If the ADMIN password is changed, be sure to keep a record of it available for service personnel or they may not be able to perform required maintenance when necessary.*

---

## 5.8.11 Z-Lock

---

This stands for zero lock. Use this to enable and configure the zero lock feature during an automated weighing process. When enabled, if the scale does not achieve a stable, gross zero condition some time within X minutes (the time you configure), then the indicator locks up and displays a message in three, one second displays: **Z-Lock Press Zero**. The operator must press **ZERO** to unlock the indicator.

**Enable** **Off** or **On**. **Off** is the default.

**Time** Use this to set the time value, in minutes, for this function. 60 minutes is the default.

## 5.8.12 Beeper

---

Use this to enable or disable the beeper sound when you press keys. **on** is the default.

## 5.8.13 Num ScI

---

Use this to key in the number of scales attached to the scale (5 max). To access settings for a scale use the **SCALE** key to display the proper scale number. Default is 1.

This completes the System menu.

## 5.9 Ports menu

Use the Ports menu to configure the scale communication ports and protocols for connection to external devices. Detailed descriptions are provided in each section below. Refer to the Ports menu map in [Figure 5.8](#).

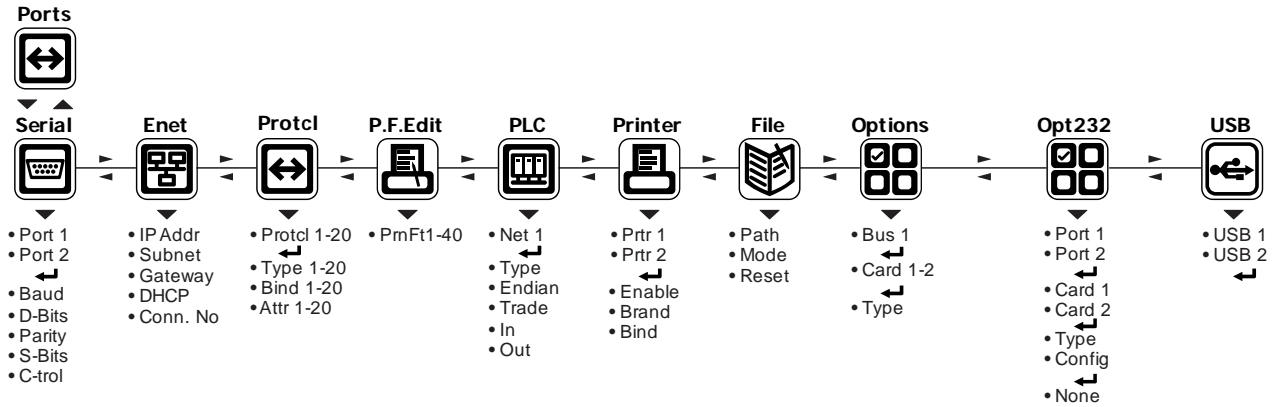

Figure 5.8 Ports menu map

### 5.9.1 Serial

Use this to set the serial communication parameters. Choose Port 1 or 2 to begin.

**Baud** Set the baud rate from the available choices. **9600** is the default value.

**D-Bits** Choose **7** or **8** data bits. **8** is the default.

**Parity** Choose **None**, **Odd** or **Even**. **None** is the default.

**S-Bits** Choose **1** or **2** stop bits. **1** is the default.

**C-Trol** Use this to set the flow control for the port. Choices for Port 1 are **None**, **Hard** or **Soft**. Choices for Port 2 are **None** or **Soft**. Default is **None** for both ports.

**Hard** Stands for hardware flow control. If wired, a device can stop the indicator and restart it for transmitting. Example is the CTS signal on a PC serial port or print busy output on a Line or Lister printer.

**Soft** Stands for software handshaking. This allows a device to start and stop the indicator transmit by sending Xon or Xoff characters.

Port 1 has both **Hard** and **Soft**. Port 2 does not have hardware handshaking.



*Hardware flow control on Port 1 is only available if **C-Trol** is set to **Hard** and Jumper P15 is in position 1. This means there will be no Port 2.*



## 5.9.2 Enet

---

Use these menu items to setup the Ethernet port.

**IP Addr** Use this to key in the static IP address of the indicator.

The IP address is the unique address for a device which is part of an Ethernet network. IPv4 is supported by this indicator. The address is a numeric entry in four parts or octets (###. ###. ###. ###).



---

*The DHCP setting is **Off** by default so the indicator will use the entered IP address for connecting directly to a PC or other static IP address devices.*

*If DHCP setting is **On** the Ethernet settings must be assigned by the network DHCP server*

---

Key in each octet and press **ENTER** to accept it.



---

*Typically devices within a network share the same address for the first three octets (network address) and each device will have a unique setting or value for the fourth octet (device address).*

---

**Subnet** The Subnet Mask address is used to divide a network into smaller subnets. The address is a numeric entry in four parts or octets (###. ###. ###. ###).



---

*Typically the subnet mask address is set to 255,255,255,0 which means the first three octets in the device network are the same and only the fourth octet of the IP address is unique for each device.*

---

Key in each octet and press **ENTER** to accept it.

**Gateway** The Gateway address allows one network a gateway to another network. The address is a numeric entry in four parts or octets (###. ###. ###. ###).



---

*In most simple networks a gateway address is not used and is set to 0,0,0,0. If the indicator is part of a network that uses an access point to another network, then a gateway address may be required. (Consult the site IT specialist)*

---

Key in each octet and press **ENTER** to accept it.

**DHCP** Use this to enable or disable DHCP capability. This allows a DHCP server to automatically set the indicator IP, subnet and gateway addresses. Choices are **On** (enabled) or **Off** (disabled). Default is **Off**.



---

*If DHCP is enabled **On**, the above settings for the IP, Subnet and Gateway are set by the network server. In applications where the indicator Ethernet port is connected directly to a PC, laptop, printer or other non-DHCP device, you must set DHCP to **Off**.*

---

**Con.No** This stands for connection number. Under this are **E-Net 1** through **E-Net 10**. These are the numbered Ethernet ports.

**E-Net 1-10** Choose the Ethernet port to set up. Choices available under

**Type x** Use this to set the type of connection; **Off**, **Client**, **Server**, **UDP** or **Clnt2**.



---

If the Ethernet port connection is to a PLC, the **Type** setting must be set to **Off**.

If **Type** is set to **Off**, it disables the selected port from communication to a server or client on the network.

The **Client** selection is typically used when the indicator(s) is connected to a print server or a shared printer on the network.

Host IP Address is only used if the **Type** setting is **Client** for this port connection.

---

If **Type** is set to **Off**

**Type x** is the only item listed under **E-Net x**. You must choose one of the other choices to see other items listed.

If **Type** is set to **Client**

**Type x**, **Port x**, **Host x**, and **Tmout x** are displayed. These are explained below.

**Port x** This stands for Remote Port. You need to pick the remote port number to send messages to and receive messages from. Key a port number from 1 to 65535.

**Host x** This is the host IP address of the server. Key in a value from 0 to 255.

**Tmout x** If no messages are received within the timeout period the socket will try to reconnect. Key in a value in seconds from 0 to 60000. Default is 0.

If **Type** is set to **Server**

**Type x** and **Port x** are displayed. Allowable values for each are listed below.

**Port x** This stands for Remote Port. You need to pick the remote port number to send messages to and receive messages from. Key in a port number from 1 to 65535.

If **Type** is set to **UDP**

UDP stands for User Datagram Protocol. **Type x**, **Port x**, **LcPrt x**, **RxAdd x**, **TxAdd x** and **DynTX x** are displayed. These are explained below.

**Port x** This stands for Remote Port. You need to pick the remote port number to send messages to and receive messages from. Key a port number from 1 to 65535.

**LcPrt x** This stands for Local Port. This is the local port that the remote IP will send messages to. Key in a port number from 1 to 65535.

**RxAdd x** This stands for Receive from Address. This is the IP address to receive messages from. A specific IP address could be specified, or an address of 0.0.0.0 could be used to receive from any remote IP address. Key in a value from 0 to 255.

**TxAdd x** This stands for Send to Address. This is the default remote IP address to send messages to. This address may not be used at all if dynamic address is set to ON. Key in a value from 0 to 255.

**DynTX x** This stands for Dynamic Address. Choices are **Off** or **On**. If **On** the firmware will change the send to IP address to the address that a message was last received from, so that a response is sent to the sender that last sent a message to the indicator. If set to **Off** then all messages will be sent to the IP address specified by the **TxAdd x** setting. Default is **Off**.

If **Type** is set to **Clnt2 x** This stands for Client 2. The socket opens and closes every time before and after sending data. **Type x**, **Port x**, **Host x**, and **Tmout x** are displayed. These are explained above.



---

*Some port numbers are reserved. Contact your IT department for the correct port number to use.*

---

### 5.9.3 Protcl

---

Use this to configure up to 20 communication protocols. These protocols define the information sent to and from specific types of communication equipment.

For each protocol you set the type, the binding and the attributes, described below.



---

*Which Attributes and Bindings apply to the selected Type will be described in the detailed descriptions below.*

---

**Type x** - Choose the method to send and receive data for Protocol x, where x = 1 to 20.

**None** Choose this to disable the selected protocol.

**Print** Choose this when you want to press the **PRINT** key or when using Autoprint to send the data through the selected binding (Port) using the associated attributes.

- ENQ** Choose this to send data when the indicator receives the configured enquire code from an external device. The information will be sent through the selected binding using the associated attributes. See *ENQ & B-Cast commands on page 57*.
- SMA** Choose this to send and receive data when using the SMA (Scale Manufacturers Association) protocol. See *SMA Protocol on page 52*. The information will be sent through the bound port using attributes that are predefined by the SMA protocol.
- B-Cast** Choose this to send data continuously through the selected binding using the associated attributes. Typical use is for remote scoreboards, displays and the Analog output option if installed. See *ENQ & B-Cast commands on page 57*.
- PLC** Choose this to send and receive data to/from a PLC network. A binding of Enet x (1 through 10) is required. The attributes are established using the PLC menu described later in this manual. See *PLC Configuration information on page 59*.
- FTP** Choose this to send data via FTP. A binding of Enet x (1 through 10) is required. The Rate attribute determines the time (in minutes) between attempted FTP updates. A second Protocol is required to complete the FTP setup. This additional protocol requires a Type x = PRINT, Bind x = File and Attributes x will need a Print Format. Also, set File Path = FTP and define the File Mode (File naming convention) in the File menu described later in this manual.
- RD** Choose this to use the indicator as a remote display. When set as a remote display, the indicator will only function as a remote display for the connected primary indicator which is connected to the weighing platform. **This requires a special application.**
- NCI** Choose this to use the NCI communication protocol. See *NCI commands on page 58*.
- Report** Choose this for reports using footers and headers.
- BSQ** Choose this when using a BSQ base.
- App** Application dependant, used for data exchange port selection.
- Hid** Use to configure an input device type, i.e. bar code scanner, RFID reader, etc., for serial, ethernet or USB interface.

**Bind x -** In this item you choose the physical connection, or hardware, for the communication for Protocol x: **Port 1-2, Enet 1** through **Enet 10, File, O.B1.C1, O.B1.C2, Prtr 1, Prtr 2, Prtr.USB** or External Bus Bindings **O.B1.C2**. Some Bindings will not apply for certain Type selections.



---

*O.B1.C1 refers to the option module in the Bus 1 and Card 1 position, O.B1.C2 refers to the option module in the Bus 1 and Card 2 position, etc.*

---

- Attr x-** In this item you choose the print format and other properties that are required for the Type and Binding selected for Protocol x. Some attributes will not apply for certain Types or Binding combinations.
- PrnFt,** Choose a print format from the documented list. Key in the format number. Print format **1** is the default.
- Inhib** This is motion inhibit. Choose **On** to enable or **Off** to disable. If enabled, data transmission or file creation will be inhibited until there is no motion on the scale or until the process times out. **Off** is the default.
- Rate** This is the transmit rate associated with broadcast type. Choices are **1, 2, 5, 10, 20, 50, 80** or **100** Hz.
- Address** Key in the node address if using an RS-485 option in a multidrop network. Choices are **1** to 254.
- Enq** Key in the enquire character used to request a print function to occur from the communications port. Choices are **0** to 255. **5** is the default value (ASCII ENQ character).
- Enq2** Key in the enquire character used to request a print function to occur from the communications port. Choices are **0** to 255. **7** is the default value (ASCII ENQ character).
- If Archive is enabled, this can be used for Archive reporting to add the transaction record and increment the counter. The default value is 7 (ASCII BEL character). Choices are 0 to 255.
- Scale** In the SMA and NCI protocols this links that protocol to that Scale for getting and setting of Data.
- In the Broadcast and Enquire Protocols this determines which scale the received commands refer to.

#### 5.9.4 P.F. Edit

---

This stands for print format editor. Please refer to the section *Print formatting on page 68* for the procedures to edit or create print formats.

#### 5.9.5 PLC

---



*If connecting to a PLC, the E-NET configuration menu does not require any special configuration and the Client/Server selection for TYPE setting must be set to OFF.*

---

- Net 1** Select these items under **Net 1:**
- Type** In this item you can choose; **Enet IP** or **M TCP**. Choose **Enet IP** to enable Ethernet IP. Choose **M TCP** to enable Modbus-TCP.

**Endian** Choices for this item are **big** or **Little**. Default is **Little**.



**ENDIAN:**

*Big = Most Significant Byte, Least Significant Byte*

*Little = Least Significant Byte, Most Significant Byte*

**Trade**

This stands for word swap or trade configuration. Choices for this item are **On** or **Off**. Default is **Off**.



**TRADE:** *On = WORD2,WORD1*

*Off = WORD1,WORD2*



*The PLC configuration determines the appropriate indicator settings for Endian and Trade.*

**In**

This stands for inbound data configuration. You will first select one of the 32 memory registers available for inbound data. Then you will select the data type and then the network token you want assigned to that memory register.

**In 1-32**

These are the 32 inbound data configuration memory registers. For each there are three choices: Type, Value, Length and Scale. See the descriptions below:

**Type**

Below is a table showing the choices for the Type, a description and a range of values for that data type.

DATA TYPE TABLE		
Typical PLC Terminology	Indicator Terminology	Data TYPE Size
CHAR / SBYTE	SINT8 - 1 byte	8 Bits (Signed Value / -127 to 127)
BYTE / UBYTE	UNIT8 - 1 byte	8 Bits (Unsigned Value / 0-255)
SHORT / SINT	SINT16 - 2 byte	16 Bits (Signed Value / -32767 to 32767)
WORD / UINT	UNIT16 - 2 byte	16 Bits (Unsigned Value / 0 to 65535)
LONG / SDINT	SINT32 - 4 byte	32 Bits (Signed Value / -2,147,483,647 to 2,147,483,647)
DWORD / UDINT	UNIT32 - 4 byte	32 Bits (Unsigned Value / 0 to 4,294,967,295)
REAL	FLOAT - 4 byte	32 Bits (Signed Decimal Value / 1.0E-37 to 1.0E37)
STRING	STRING - 1 byte/char	Length Parameter setting



*The Type and order of the Values selected must coincide with the configuration of the PLC register setup. Consult with the site IT specialist.*

**Value** This stands for the network token value to be assigned to the inbound data memory register. Key in the value for the network token you want from the table above and press **ENTER** to accept the displayed choice ...

Repeat the process for any other inbound memory registers you want to configure.

**Length** Set the length of the string. (Only for strings.)

**Scale** Choose from connected scales.

**Out** This stands for outbound data configuration. This menu item is exactly like the **in** menu item except it is for outbound data. Follow the same process to set up the 32 memory registers.

## 5.9.6 Printer

---

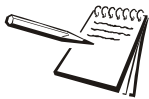

The **Printer** menu is used when the indicator is interfaced with one of the printers listed in the **Brand** submenu. This is necessary to ensure all the appropriate control codes are added to the selected print format.

If either **PRTR1** or **PRTR2** selections are enabled then the port that is **Binded** may occasionally send out a set of random characters to test for a connected printer. Be sure to disable these settings if the indicator is not connected to one of the printer brands listed.

---

**Prtr 1** You can choose to set up this printer or **Prtr 2**. The setup procedure is the same.

**Enable** Choices under this item are **Off** (default) or **On**.

**Brand** Choices under this item are the five printer models supported by this indicator: **Zebra**, **EpsnPos**, **HP 14--**, **HP15--** and **HP85--**.

**Bind** Choices under this item are: **Port 1**, **Port 2** and **E-Net 1** through **E-Net 10**. Choose which port the printer output is attached to.

## 5.9.7 File

---

Use this item to configure how and where files are saved.

**Path** Use this to choose where the file is saved, internally for transfer by **FTP** using an Ethernet port, to a connected **USB** flash drive or to an **SDCARD**.

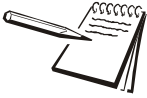

---

When the **FILE > PATH** is set for **USB** or **SDCard**, a **USB** flash drive or **SD** Card can be installed into the **Host** port and transactions will be transferred as they occur. If the flash drive or card is not installed, transactions will be saved onto the **Flash** memory in the indicator.

The size of the print format will determine the number that can be stored but with a typical print format the indicator should be capable of storing several thousand transactions. The saved transactions will transfer immediately when the **USB** flash drive or **SD** CARD is re-installed. The message **Copying** will display as each stored file is transferred to the flash drive or card. This could take a few seconds to transfer each file. Do not remove the flash drive or card until the message **Done** is finally displayed. Stored transactions will then be cleared after the transfer.

---

**Mode** Use this to configure the file convention. Choices are:

**Constant** This will create a single file that will be appended to as new information is saved.

**NUMBRD** This will create new file appended with a sequential number for each transaction.

**D\_T** This will create a new file and the file name will be appended with the date and time (including seconds) for each transaction.



---

**Filename Examples:**

<Scale Name>\_<SERIAL>XXXXXX.txt

where <Scale Name> is the scale name, <Serial> is the serial number, XXXXXX is either nothing, the sequential number, or the time and date.

Sequential number increments from 000001 – 999999 ... when **RESET** starts at 000001

Date = YYYY\_MM\_DD\_\_HH\_MM\_SS  
with double underscore between DD and HH

**Examples:**

Constant: 120450001.txt

Numbered: 120450001\_000001.txt

D\_T: 120450001\_2012\_01\_31\_\_10\_31\_23.txt

If transactions are being store on the indicator **Flash** memory, only a single **Constant** or **Numbered** file will be created. If using the **Date & Time** file naming convention then individual files will be created.

---

**Reset** Reset will clear all stored transactions and also reset the numbered file sequence to 000001.



## 5.9.8 Options

---

Use this parameter to enable any of the available option cards.

**Bus 1** Choose the Bus.

**Card 1or2** Choose the card position.

**Type** Choose the type of card installed from this list:

- Wireless Ethernet (802.11g)

The **Scale** menu item is for this input cards

- 5VDC Excitation Analog Scale Input card

Depending on the choice made for **Type**, a **Config** menu may appear. Below are the Config and/or Calibration menus that may appear for the installed card.

## 5.9.9 Opt232

---

Use this parameter to configure cards on the option; Expansion RS232 cards.

## 5.9.10 USB

---

Use this to choose between USB 1 and USB 2 for setting the debounce for the keyboard or scanner input character delay timing.

## 6 Application menu

The Application menu, shown in [Figure 6.1](#) allows access to the items related to the indicator's function that you can set or enable/disable.

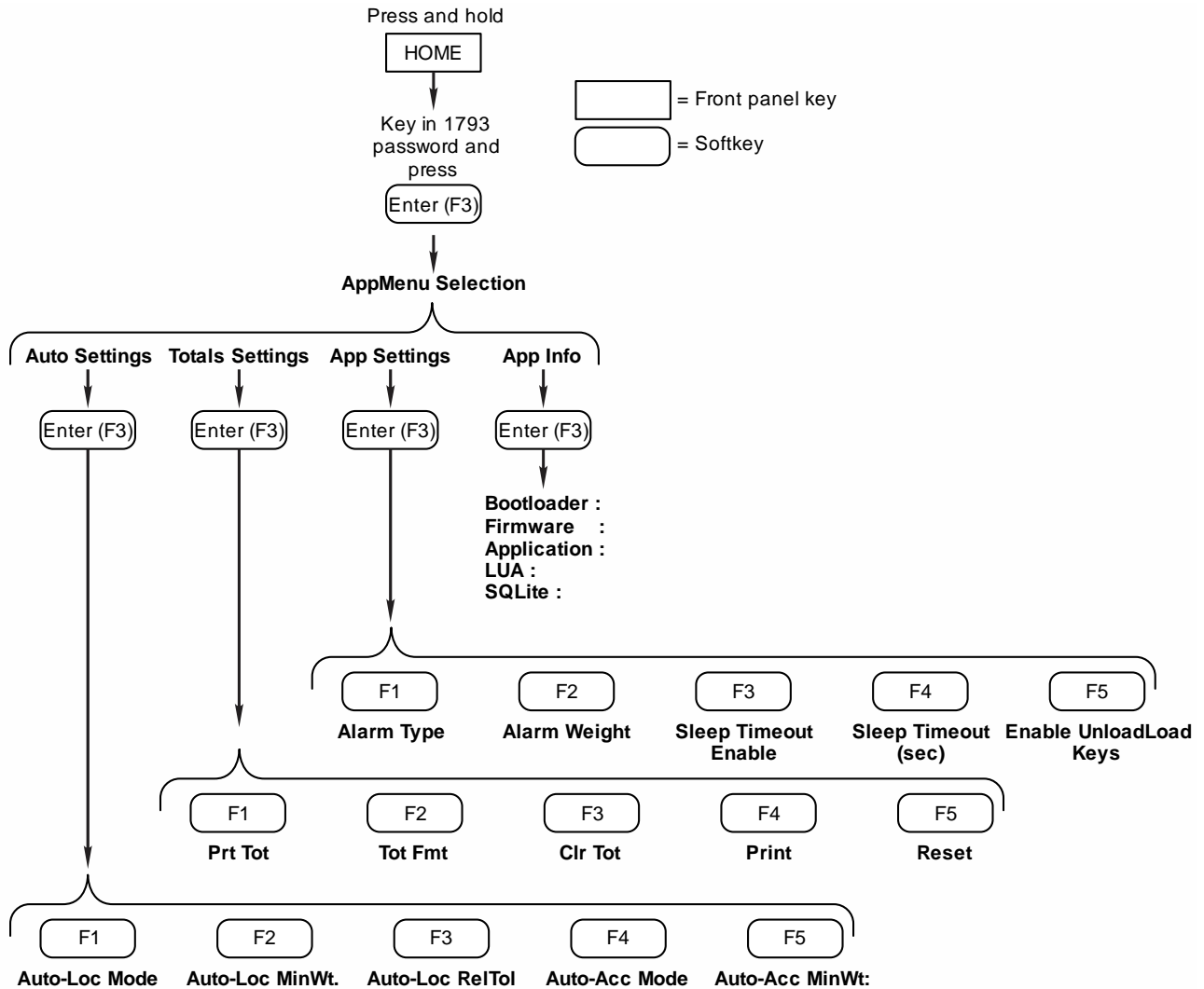

**Figure 6.1 Application menu**

How each of the items affects the indicator's operation is explained below.

## 6.1 Accessing the Application menu

---

Refer to the menu in [Figure 6.1](#) as you go through these instructions to familiarize yourself with the menu.

1. Press and hold the **HOME** key ...

The password entry screen is displayed, shown below.

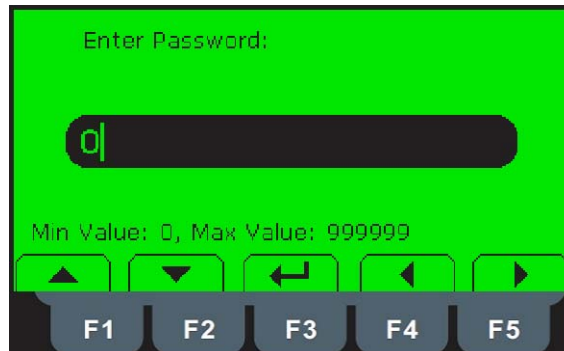

2. Key in the password, 1793, and press the **Enter (F3)** (↵) softkey.

The following screen is displayed.

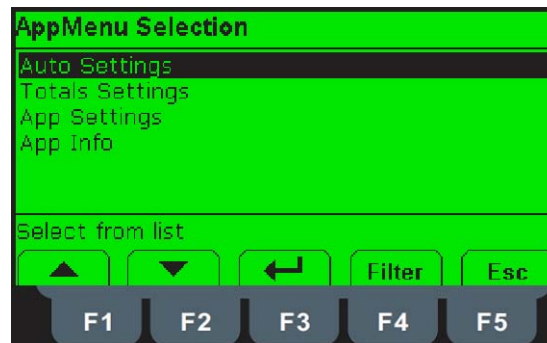

3. Highlight any of the items in the list by using the **UP** or **DOWN** softkeys. When your selection is highlighted, press the **Enter** key to access the menu item.

Each item is explained in its own following section:

See *Auto Settings* on page 84.

See *Totals Settings* on page 85.

See *App Settings* on page 85.

See *App Info* on page 86.

## 6.2 Auto Settings

---

**Auto-Loc Mode** This feature is specifically designed for use in weighing livestock. Once the indicator has determined the animal's weight, the indicator display automatically locks on that weight. The weight reading will not change as long as the animal is on the scale. This makes the weight easy to record since the numbers are not rapidly changing as the animal moves on the scale.

There are three settings for the Auto-Loc mode:

**Disabled** This disables this feature.

**Standard** In standard mode, an animal's weight is locked on the display until the animal leaves the scale.

**Advanced** In advanced mode, an animal's weight is locked on the display until the next animal comes onto the scale.

**Auto-Loc MinWt.** **MinWt.** stands for Minimum Weight. Use this to prevent an inadvertent AUTO-LOC if someone leans/steps on the scale. We recommend putting in a large amount for the MinWt. parameter to prevent this from occurring. (EX: 300 lb)

**Auto-Loc RelTol** **RelTol** stands for Release Tolerance. Weight stays locked until the weight on the scale drops by the release tolerance in percentage.

Example: Weighing a 2000 lb animal with a 25% release tolerance, means the lock will release when weight drops below 1500 lb. If the animal is released and the weight falls below the tolerance it may be possible to lock on another weighment. We recommend putting in a high release tolerance like 75% to insure reliable operation.

**Auto-Acc Mode** This stands for auto-accumulate. This can be set to **ON** or **OFF**. If you set this mode to **ON**, once a weight is locked, the indicator will automatically accumulate to the last selected memory channel.

**Auto-Acc MinWt:** This is the minimum amount of weight that will trigger an auto-accumulate weighment. This will help prevent false weighments in case someone steps on the scale between weighing animals. We recommend putting in a large amount for the **MinWt** parameter to prevent this from occurring. (EX: 300 lb).

## 6.3 Totals Settings

<b>Prt Tot</b>	Enable or disable the automatic printing of the accumulation totals after each accumulation weighment.
<b>Tot Fmt</b>	Use this to choose the print format you want to use in the accumulation printout.
<b>Clr Tot</b>	Enable or disable the automatic clearing of the accumulator channel.



To print totals, press and hold the **PRINT** key until **CLr tot** flashes in the lower left corner of the display. The totals will be cleared based on the **Clr Tot** setting.

<b>Print</b>	Use this to pick a port you want to use to print the report: <b>Port 1</b> , <b>Port 2</b> or <b>USB</b> .
<b>Reset</b>	Use this to reset the entire database to factory defaults.

## 6.4 App Settings

Key	Setting Description	Choices	Default	Comments
F1	Alarm Type	Percent	Percent	Percent alarm light will flash when this % of target is met and will become solid once target is met.
		Weight		Weight Alarm light will flash once within this weight parameter of target and be solid once target is met.
		Preact		Preact (Not enabled yet).
F2	Alarm Percent	-	10.00 %	enter a alarm percent value
F3	Auto Print When Save	OFF	OFF	When OFF, the user has to press print to get a printout for a transaction.
		ON		When default is ON, transactions will print automatically when transaction is saved in the Planting or Harvest app.
F4	Seed Probox Tare	-	330.00 lb	This sets the default tare weight for a Probox. When loading a Probox tender and reset is selected the weight of the Probox will be deducted so when the Probox is loaded the weight shows the true seed weight.
F5	P2P Radio Address	-	0	Feature is not enabled.Future option.

### Alarm Type -

**Percent** Percent alarm light will flash when the percentage of target is met and will become solid once target is met.

**Weight** Weight Alarm light will flash once within the weight parameter of target and be solid once target is met.

<b>Preact</b>	Alarm light will be constant when within the weight or percent setting. Uses the alarm output. A "Preact" weight can be set which activates the alarm output X amount of lbs before target. Example: If on a tender, and there is typically 20 lb of freefall after auger/conveyor is turned off, it will increase the accuracy of meeting the actual target value.
<b>Alarm Weight</b>	If <b>Percent</b> is chosen as the <b>Alarm Type</b> , this item will read <b>Alarm Percent</b> . This is where you enter the weight or percent parameters for the items under <b>Alarm Type</b> .
<b>Sleep Timeout Enable</b>	Enable or disable the sleep timer. If enabled the indicator will power down once the amount of time you set in <b>Sleep Timeout</b> , below, has elapsed with no scale or indicator activity.
<b>Sleep Timeout (sec)</b>	Set the amount of inactive scale and indicator time which will trigger a power down of the indicator.
<b>Enable UnloadLoad Keys</b>	Enable or disable <b>Unload</b> and <b>Load</b> keys on the main display.

## 6.5 App Info

---

<b>Bootloader:</b>	Select this to see the current version of the bootloader.
<b>Firmware:</b>	Select this to see the current version of the firmware.
<b>Application:</b>	Select this to see the current version of the application.
<b>LUA:</b>	Select this to see the current version of LUA.
<b>SQLite:</b>	Select this to see the current version of the SQLite.



# Avery Weigh-Tronix

---

**24/7 Service  
800-458-7062**

**Avery Weigh-Tronix USA**

1000 Armstrong Dr.  
Fairmont MN 56031 USA  
Tel:507-238-4461  
Fax:507-238-4195  
Email: [usinfo@awtxglobal.com](mailto:usinfo@awtxglobal.com)  
[www.agscales.com](http://www.agscales.com)

**Avery Weigh-Tronix UK**

Foundry Lane,  
Smethwick, West Midlands,  
England B66 2LP  
Tel:+44 (0) 8453 66 77 88  
Fax: +44 (0)121 224 8183  
Email: [info@awtxglobal.com](mailto:info@awtxglobal.com)  
[www.averyweigh-tronix.com](http://www.averyweigh-tronix.com)



To access manuals on  
the Ag website